

If you are reading this electronically, the Council has saved **£1.38** on printing. For more information on the Mod.gov paperless app, contact Democratic Services

# Merton Council

## Planning Applications Committee

### Membership

#### Councillors

Linda Kirby (Chair)  
Najeeb Latif (Vice-Chair)  
David Dean  
Russell Makin  
Simon McGrath  
Peter Southgate  
Billy Christie  
Rebecca Lanning  
Joan Henry  
Dave Ward

#### Substitute Members:

David Chung  
Edward Foley  
Stephen Crowe  
Daniel Holden  
Carl Quilliam  
John Dehaney

A meeting of the Planning Applications Committee will be held on:

**Date: 28 May 2020**

**Time: 7.15 pm**

**Venue: This will be a virtual meeting and therefore will not take place in a physical location, in accordance with s78 of the Coronavirus Act 2020.**

This is a public meeting and can be viewed by following this link  
<https://www.youtube.com/user/MertonCouncil>.

For more information about the agenda and the decision making process contact [democratic.services@merton.gov.uk](mailto:democratic.services@merton.gov.uk) or telephone 020 8545 3356

Press enquiries: [communications@merton.gov.uk](mailto:communications@merton.gov.uk) or telephone 020 8545 3181

For more information about Merton Council visit [www.merton.gov.uk](http://www.merton.gov.uk)

# Planning Applications Committee

## 28 May 2020

- 1 Apologies for absence
- 2 Declarations of Pecuniary Interest
- 3 Minutes of the previous meeting 1 - 6
- 4 Town Planning Applications  
The Chair will announce the order of Items at the beginning of the Meeting.  
A Supplementary Agenda with any modifications will be published on the day of the meeting.  
Note: there is no written report for this item
- 5 2 Madison Heights, 2A Milner Road, Wimbledon, SW19 3AA 7 - 36  
Application Number: 19/P3365 Ward: Abbey  
  
Officer Recommendation: GRANT Planning Permission subject to conditions and S106 Agreement
- 6 The All England Lawn Tennis and Croquet Club, Church Road, Wimbledon, London, SW19 5AE 37 - 38  
  
In light of a representation received this report asks members to consider whether they wish to make any further comments on the application
- 7 Planning Enforcement - Summary of Current Cases 39 - 44  
  
Officer Recommendation:  
That Members note the contents of the report.

### **Declarations of Pecuniary Interests**

Members are reminded of the need to have regard to the items published with this agenda and, where necessary to declare at this meeting any Disclosable Pecuniary Interest (as defined in the The Relevant Authorities (Disclosable Pecuniary Interests) Regulations 2012) in any matter to be considered at the meeting. If a pecuniary interest is declared they should withdraw from the meeting room during the whole of the consideration of that matter and must not participate in any vote on that matter. If members consider they should not participate because of a non pecuniary interest which may give rise to a perception of bias, they should declare this, withdraw and not participate in consideration of the item. For further advice please speak with the Council's Managing Director, South London Legal Partnership.

### **Declarations of Pecuniary Interests – Members of the Design and Review Panel (DRP)**

Members of the Planning Applications Committee (PAC), who are also members of the DRP, are advised that they should not participate in an item which has previously been to DRP where they have voted or associated themselves with a conclusion reached or recommendation made. Any member

of the PAC who has also sat on DRP in relation to items on this PAC agenda must indicate whether or not they voted in such a matter. If the member has so voted they should withdraw from the meeting.

**Human Rights Implications:**

The applications in this Agenda have been considered in the light of the Human Rights Act 1998 and in particular, the First Protocol of Article 1 (Protection of Property); Article 6 (Rights to a Fair Trial) and Article 8 (Private and Family Life).

Consideration has been given to the impact of each application on the people living and working in the vicinity of that particular application site and to the impact of the proposals on the persons who have made written representations on the planning merits of the case. A full assessment of material planning considerations has been included in each Committee report.

Third party representations and details of the application proposals are summarised in each Committee report. It may be that the policies and proposals contained within the Development Plan and/or other material planning considerations will outweigh the views of third parties and/or those of the applicant.

**Order of items:** Applications on this agenda are ordered alphabetically. At the meeting the Chair may change this order to bring forward items with the greatest number of public speakers. The new order will be announced by the Chair at the start of the meeting.

**Speaking at Planning Committee:** All public speaking at Planning Committee is at the discretion of the Chair. The following people may register to speak:

Members of the Public who have submitted a written representation objecting to an application. A maximum of 6 minutes is allowed for objectors. If only one person registers they will get 3 minutes to speak, a second person will also get 3 minutes. If further people want to speak then the 6 minutes may be shared between them

Agents/Applicants will be able to speak but only if members of the public have registered to speak in opposition to the application. Applicants/agents will get an equal amount of time. If an application is brought to Committee with an Officer recommendation for Refusal then the Applicant/Agent will get 3 minutes to speak.

**All Speakers MUST register in advance**, by contacting The Planning Department no later than 12 noon on the day before the meeting.

**PHONE:** 020-8545-3445/3448

**e-mail:** [planning@merton.gov.uk](mailto:planning@merton.gov.uk))

Ward Councillors/Other Councillors who are not members of the Planning Committee may also register to speak and will be allocated 3 minutes each. Please register with Development Control Administration or Democratic Services no later than 12 noon on the day before the meeting

**Submission of additional information before the meeting:** Any additional information relating to an item on this Agenda should be sent to the Planning Department before 12 noon on the day before the meeting (using email above).

**Please note:**

There is no opportunity to make a visual presentation when speaking at Planning Committee

That the distribution of any documents by the public during the course of the meeting will not be permitted.

**FOR ANY QUERIES ON THIS INFORMATION AND OTHER COMMITTEE PROCEDURES** please contact Democratic Services:

Phone – 020 8545 3356

e-mail – [democratic.services@merton.gov.uk](mailto:democratic.services@merton.gov.uk)

# Agenda Item 3

All minutes are draft until agreed at the next meeting of the committee/panel. To find out the date of the next meeting please check the calendar of events at your local library or online at [www.merton.gov.uk/committee](http://www.merton.gov.uk/committee).

## PLANNING APPLICATIONS COMMITTEE

14 MAY 2020

(7.15 pm - 9.19 pm)

PRESENT: Councillor Linda Kirby (in the Chair), Councillor Najeeb Latif, Councillor David Dean, Councillor Russell Makin, Councillor Simon McGrath, Councillor Peter Southgate, Councillor Billy Christie, Councillor Rebecca Lanning, Councillor Joan Henry and Councillor Dave Ward

ALSO PRESENT: Sarath Attanayake, Tim Bryson (Development Control Team Leader (North)), Jonathan Lewis (Development Control Team Leader (South)), Neil Milligan (Development Control Manager, ENVR), Amy Dumitrescu (Democratic Services Officer) and Louise Fleming (Senior Democratic Services Officer)

### 1 APOLOGIES FOR ABSENCE (Agenda Item 1)

There were no apologies for absence.

### 2 DECLARATIONS OF PECUNIARY INTEREST (Agenda Item 2)

There were no declarations of interest.

### 3 MINUTES OF THE PREVIOUS MEETING (Agenda Item 3)

RESOLVED: That the minutes of the meeting held on 19 March 2020 are agreed as an accurate record.

### 4 TOWN PLANNING APPLICATIONS (Agenda Item 4)

Supplementary Agenda: Amendments and modifications to the Officer's report were published in a Supplementary Agenda. This applied to items 5 and 6.

The Chair announced that there would be no change to the order of items in the published agenda.

### 5 2 CHURCH LANE, SW19 3NY (Agenda Item 5)

Proposal: The demolition of former two storey Doctors' Surgery and erection of a three storey residential block providing 8 self-contained flats.

The Committee noted the officer's report and presentation, including the additional condition proposed as set out in the supplementary agenda.

Two objectors had registered to speak and had submitted written statements which were read out by the Senior Democratic Services Officer at the request of the Chair. The statements raised points relating to overlooking, loss of privacy and light, noise impact and the proximity of the refuse bins to neighbouring property. A written

statement on behalf of the applicant was also read out, setting out the adjustments made to address the concerns of neighbouring residents and the benefits the scheme would bring to the area.

The Development Control Team Leader South addressed the points raised by the objectors in respect of overlooking, loss of light and loss of privacy. He advised the Committee that if it was minded to approve, an additional condition could be added to request complete obscure glazing on the kitchen window in question. He demonstrated on plans the separation distances which were not close enough to warrant refusal and officers felt that the applicant was acceptable in terms of light.

In response to questions from Members, the Development Control Team Leader South advised:

- officers considered the location of the cycle and refuse storage to be reasonable.
- it would be reasonable to request obscure glazing and privacy screen up to 1.6 or 1.7m high if Members were minded.
- officers did not consider the distance between the windows of the proposal and the windows of No. 85 to be unreasonable.
- there would be no reduction or harm to amenity space and existing trees should be retained.
- the previous application was for 9 units and the current proposal was for 8 units and the previous application did not meet floor space standards, whereas the current application did meet the standards.
- each application must be considered on its own merits and the particular conversation area, therefore standard construction times would not be appropriate in this case.

The Chair adjourned the meeting at 7.58pm and resumed at 8.05pm

Members made a number of comments, including:

- Some felt that the application was a good scheme overall, although there were concerns over refuse storage and the proximity to the bedroom of flat 3.
- There were some concerns in respect of overlooking and privacy, which had not been dealt with and it was felt that the application should be rejected on that basis.
- Some felt that the proposal would make a positive contribution to developing the area and would deliver important housing provision.
- An additional condition relating to provision of Swift boxes was requested.

Development Control Team Leader South confirmed that a condition relating to swift boxes could be accommodated.

At the conclusion of the debate the Chair called for a vote on the recommendation to approve planning application, with the addition of the condition set out in the supplementary agenda and the condition relating to swift boxes and it was

**RESOLVED** that Planning Permission be **GRANTED** subject to conditions and a s106 agreement or any other enabling agreement.

6 AELTC, CHURCH ROAD, SW19 5AE (Agenda Item 6)

Proposal: The erection of a two storey media pavilion, replacement of temporary cabins with a dedicated technical services room (TSR), and reconfiguration of gate 20 including the relocation and widening of existing access/egress, relocation of existing gatehouse building, new accreditation hut and gatehouse building, landscaping and associated works.

The Committee noted the officer's report and presentation, including the additional conditions proposed as set out in the supplementary agenda.

A statement had been received on behalf of a residents association which was read out by the Senior Democratic Services Officer at the request of the Chair. Whilst not objecting to the application, concerns were raised over the environmental impact of the proposed scheme and the continued enlargement of the facilities over time and a request that the s106 agreement includes provision for road and pavement maintenance and parking controls. A written statement on behalf of the applicant was also read out, addressing the concerns of neighbouring residents and the benefits the scheme would bring to the area.

The Development Control Team Leader North addressed the points raised in the written submission and advised that traffic would not be increased by the proposal, it would be moved to a different part of the site. The Council did not have the authority to include a private road in the s106 legal agreement as proposed by residents and nor could we include environmental measures, such as road maintenance, given the size of the proposal and what it relates to.

The Vice-Chair advised that he had taken part in meetings with both the applicant and the Residents Association and therefore would not be voting on the application. The Vice-Chair left the meeting at 8.45pm and did not return for the remainder of this item.

In response to questions from Members, the Development Control Team Leader North advised that the parking provision on the underground parking facility in Somerset Road would reduce the pressure on parking in the area and standard construction hours were proposed.

At the conclusion of the debate the Chair called for a vote on the recommendation to approve planning application, with the addition of the conditions set out in the supplementary agenda and it was

RESOLVED that Planning Permission be GRANTED subject to conditions and a s106 agreement.

7 28 LAURISTON ROAD, SW19 4TQ (Agenda Item 7)

Proposal: Demolition of existing detached dwelling house and the erection of a new single storey dwelling house with accommodation at basement level) and provision of off-street parking and associated landscaping works.

The Committee noted the officer's report and presentation.

In response to questions from Members, the Development Control Team Leader North advised that additional planting was proposed and the species of trees would be determined by condition. Officers were not aware of a Controlled Parking Zone in operation in the area and advised that this was not grounds for refusal.

At the conclusion of the debate the Chair called for a vote on the recommendation to approve planning application and it was

RESOLVED that Planning Permission be GRANTED subject to conditions.

(The Vice-Chair was not present for the duration of this item.)

8 87 ROBINSON ROAD, SW17 9DN (Agenda Item 8)

Proposal: Demolition of existing building and outbuilding and erection of a two storey building plus lower ground floor level, to contain 8 x self-contained flats with off street parking spaces, cycle storage and refuse storage.

The Committee noted the officer's report and presentation.

One objector had registered to speak and had submitted a written statement which was read out by the Senior Democratic Services Officer at the request of the Chair. The statement raised points relating to fire safety and the narrow access and egress which was felt to be unsuitable and unsafe. A written statement on behalf of the applicant was also read out, setting out the adjustments made to address earlier concerns relating to design, bulk, light and parking.

The Development Control Team Leader South addressed the points raised in the written submission relating to fire safety and advised that this had been addressed through condition to require the applicant to implement a fire safety plan to the satisfaction of the London Fire Brigade. He also advised that it was not possible to alter the dimensions of the driveway and that officers did not consider that the dimensions were unreasonable.

In response to questions from Members, the Development Control Team Leader South advised that the middle property was single aspect and demonstrated the location of the windows.

Some Members noted that the development would add to the housing stock and did not feel that the application would be detrimental.

At the conclusion of the debate the Chair called for a vote on the recommendation to approve planning application and it was

RESOLVED that Planning Permission be GRANTED subject to conditions and a unilateral undertaking to restrict eligibility to parking permits.



(The Vice-Chair was not present for the entirety of the debate on this item and therefore could not vote.)

9 PLANNING APPEAL DECISIONS (Agenda Item 9)

The Committee noted the report on recent Planning Appeal Decisions.

10 PLANNING ENFORCEMENT - SUMMARY OF CURRENT CASES (Agenda Item 10)

The Committee noted the report on recent planning enforcement.

This page is intentionally left blank

## PLANNING APPLICATIONS COMMITTEE

28<sup>th</sup> May 2020

<u>UPRN</u>	<u>APPLICATION NO.</u>	<u>Item No:</u> <u>DATE VALID</u>
	19/P3365	19/09/2019
<b>Address/Site</b>	Madison Heights, 2a Milner Road, South Wimbledon, SW19 3AA	
<b>(Ward)</b>	Abbey	
<b>Proposal:</b>	Erection of a 2 storey roof extension comprising of 5 self contained units (1 x studio 2 x 1 bed & 2 x 2 bed flats)	
<b>Drawing Nos</b>	18019 FP 01.01, 18019 FP 01.03 Rev H, 18019 FP 01.04 Rev E, 18019 FP 01.05 Rev G and, 18019 FP 01.07 Rev B.	
<b>Contact Officer:</b>	Stuart Adams (0208 545 3147)	

---

### RECOMMENDATION

**GRANT Planning Permission subject to S106 agreement and conditions .**

### CHECKLIST INFORMATION.

- ) Heads of agreement: - Permit free
  - ) Is a screening opinion required: No
  - ) Is an Environmental Statement required: No
  - ) Has an Environmental Impact Assessment been submitted – No
  - ) Press notice – No
  - ) Site notice – Yes
  - ) Design Review Panel consulted – No
  - ) Number of neighbours consulted –
  - ) External consultations – No.
  - ) PTAL score – 6a
  - ) CPZ – S1
-

## 1. **INTRODUCTION**

- 1.1 The application has been brought before the Planning Application Committee for consideration in light of the number of objections received against the application and officer recommendation of grant permission subject to conditions and S106 agreement.

## 2. **SITE AND SURROUNDINGS**

- 2.1 The site is located on the northern side of Milner Road at the corner of the junction with Morden Road in South Wimbledon. The application site is a recently built six storey mixed use building. The use of the ground floor is currently Class D2 with 15 self-contained residential units located above.
- 2.2 To the northeast is a recently erected three storey block comprising a commercial unit (Costa Coffee) on the ground floor with two floors of flats above with roof terraces to the rear. Beyond is a Tesco local store with residential accommodation above. To the north is the rear of a Kwik-Fit car, repair/tyre and exhaust fitting garage with a driveway to the rear of the Kwik-Fit garage along the western boundary. Beyond the Kwik Fit rear driveway is a second driveway providing servicing and parking to Grenfell Housing's offices located in a three storey building which along with the Kwik Fit garage front Kingston Road. Beyond to the west is two-storey terraced housing in Milner Road beyond.
- 2.3 An emergency access gate is situated on Milner Road approximately 50m from the junction of Milner Road with Morden Road. This restricts access for all vehicles except emergency vehicles towards Queensland Road and Brisbane Avenue. Either side of the gate, Milner Road offers two-way movement in an east to west direction. There is one permit holder bay to the east of the gate near the site. To the west of the gate, Milner Road provides on-street parking subject to CPZ restrictions offering both permit holder and pay & display parking.
- 2.4 To the south is Spur House has recently undergone refurbishment and extension to provide a 9 storey block of flats with retail on the ground floor while the rear part of the Spur House site fronting Milner Road has permission for 3/4 storey residential accommodation. Adjoining Spur House to the south is a three storey block of offices with a branch of Barclays Bank on the ground floor.
- 2.5 On the opposite side of Morden Road is the Grade II listed South Wimbledon underground station along with associated kiosks and

- shops and adjoining to the south is a small vehicle sales and hire yard.
- 2.6 On the opposite side of Morden Road to the south is a four storey block of flats, Gilbert Close.
- 2.7 The High Path estate on the opposite side of the road has been granted outline planning application (with all matters reserved, except in relation to parameter plans) for the comprehensive phased regeneration of high path estate comprising demolition of all existing buildings and structures; erection of new buildings ranging from 1 to 10 storeys max, providing up to 1570 residential units (C3 use class); provision of up to 9,900 sqm of commercial and community floorspace (inc replacement and new floorspace, comprising: up to 2,700 sqm of use class a1 and/or a2, and/or a3 and/or a4 floorspace, up to 4,100 sqm of use class b1 (office) floorspace, up to 1,250 sqm of flexible work units (use class b1), up to 1,250 sqm of use class d1 (community) floorspace; up to 600 sqm of use class d2 (gym) floorspace); provision of new neighbourhood park and other communal amenity spaces, incl. children's play space; public realm, landscaping, lighting; cycle parking (incl visitor cycle parking) and car parking (inc within ground level podiums), associated highways and utilities works.
- 2.8 The application site is within a Controlled Parking Zone and has a Public Transport Accessibility Level [PTAL]: Level 6A (TFL Information Database [On a scale of 1a, 1b, and 2-5, 6a, 6b where zone 6b has the greatest accessibility]. The Northern Line tunnels run in an arc under the eastern edge of the site
- 2.9 The site is located within the Colliers Wood/South Wimbledon Area of Intensification as identified in the London Plan.
- 2.10 A covered Thames Water culvert runs under the eastern part of the site. The site is in Flood Zone 1 (Low risk).
- 2.11 The application site is not located in a Conservation Area
3. **CURRENT PROPOSAL**
- 3.1 Erection of a 2 storey roof extension comprising of 5 self contained units (1 x studio 2 x 1 bed & 2 x 2 bed flats). The proposal would take the number of flats in the building from 15 to 20.
- 3.2 The proposed flats would have the following GIA and amenity space standards.

Unit	Dwelling type (bedroom (b)/ persons- bedspaces (p))	Amenity Space	Amenity Space Standards	GIA (sq m)	London Plan standard
Flat 1	Studio	4.4	5	39.4	39
Flat 2	1b2p	5.6	5	58.8	50
Flat 3	1b2p	10.2	5	61.5	50
Flat 4	2b4p	12.2	7	73.1	61
Flat 5	2b3p	6.6	6	61.2	61

#### 4. **PLANNING HISTORY**

- 4.1 18/P0562 - Erection of a roof extension comprising of 3 self contained units 1 x studio 2 x 1 bed – Grant - 04/10/2018
- 4.2 17/P0932: Application to discharge condition 15 (screening to balconies & terraces) attached to LBM planning permission 15/P0377 relating to the erection of mixed use block comprising retail (A1) or (cafe/restaurant) a3 at ground floor (170 sq.m) with 15 self-contained flats (5 x 1 bedroom and 10 x 2 bedroom) above in a six storey block with a stairwell overrun at roof level and 3 (3 bedroom) town houses arranged on 3 floors with stairwell at roof level providing access onto an amenity deck - Granted.
- 4.3 16/P4530 - Non-material amendment under s96a to vary condition 2 (approved plans) attached to LBM planning permission 15/P0377 relating to the provision of 2x conservatory extensions at the proposed erection of mixed use block comprising retail (A1) or (cafe/restaurant) A3 at ground floor (170 sq.m) with 15 self-contained flats (5 x 1 bedroom and 10 x 2 bedroom) above in a six storey block with a stairwell overrun at roof level and 3 (3 bedroom) town houses arranged on 3 floors with stairwell at roof level providing access onto an amenity deck. - Granted.
- 4.4 15/P0377 - Erection of mixed use block comprising retail (A1) or (cafe/restaurant) A3 at ground floor (170 sq.m) with 15 self-contained flats (5 x 1 bedroom and 10 x 2 bedroom) above in a six storey block with a stairwell overrun at roof level and 3 (3 bedroom) town houses arranged on 3 floors with stairwell at roof level providing access onto an amenity deck. - Granted.

#### 5. **CONSULTATION**

- 5.1 The application has been advertised by site notice procedure and letters of notification to the occupiers of neighbouring properties.
- 5.2 21 letters of objection have been received. The letters raise the following concerns:

## Design

- ) The proposed extension would have an adverse effect on the character and architectural landscape of the local area.
- ) If the application is granted, Madison Heights will become the highest building in the area, dominating the local area and appear incongruous with surrounding buildings.
- ) The cladding and variation in design will have the effect of a high-rise building
- ) The planned materials (brown metal cladding) do not complement the current appearance (grey ceramic tiles), making the development an eyesore.
- ) There is no need for another high rise is Milner Road.
- ) The building as it stands now is incredibly unsightly and is an eyesore that can be seen for miles.
- ) When the planning application was first proposed for this building we were informed that that the building would blend in with the character of the existing houses on the road. However this was not the case at all. The cladding and the design of the building doesn't blend in and If another two stories are built, it will even more unsightly than it is now and completely destroy the look of the surrounding area.
- ) The previous consent for a single storey roof extension was finished in the same cladding. - The current application is seeking to introduce a brown metal cladding. This will not merge well with the building and will look as though the additional floors have been 'bolted on' as an afterthought.
- ) High density
- ) Does not mirror the design of the other flats in the building
- ) No family accommodation.

## Neighbour Impact

- ) Disruption during construction (noise, dust, construction vehicles etc)
- ) Loss of light. Findings of sun and daylight report not agreed or accurate.
- ) Visual intrusion and overbearing.
- ) Loss of views and skyline
- ) No pollution study to show the impact of the pollution 'Canyon' effect. Pollution levels are now extremely high and above safe and legal limits already.
- ) Overlooking from balconies.

- ) No air quality or noise assessment. In this busy location like this is of paramount importance.
- ) The construction also poses an unsightly view of the property as building two extra storeys will require a substantial amount of scaffolding for a longer period of time

### Highways

- ) Parking problems in the existing CPZ
- ) Adequacy of parking/loading/turning and traffic generation
- ) Not support any restriction to vehicle access to our company carpark and fire exit, on Milner Road, during the construction of the extension.
- ) We have a situation already with abandoned cars , litter, non resident cars jammed here on a Sunday, residents who are not allowed to park in our zone not being patrolled
- ) No additional parking study or traffic study to show the additional vehicle movements. This end of Milner Road is full of parked cars (often from this development) after the residents parking finishes in the evening and weekends. No impact statement of additional deliveries or visitors to this development.
- ) Development should not interfere with the new landscaping and road entry proposals for Milner Road
- ) Storage of materials should not be on Milner Road or pavements during work as previously done during the build of Maddison Heights without licence or informing local residents
- ) bike store has the capacity for 38 bicycles is completely unrealistic; again there is no extra space within the building to extend this area.

### Structural

- ) Existing issues with the structural design of the building which are yet to be Resolved. The building already has structural problems that developers and property management have failed to address; leaks in the same exact spots in each flat (balcony/kitchen area), causing concern to how these will be prioritised and fixed, or potentially magnified if extra construction is put on top of the building.
- ) The building has suffered major leaking in the basement where there is a bike storage area. There are also more and more cracks in the wall starting to appear (photos attached) and some foundation cracks. The freehold owner has taken no action to even acknowledge the problem and so looking unlikely that he will take any steps to rectify it.



- ) On a side safety note, I hope that the developers are talking to TFL about the fact this is extra weight on top of what is basically a tube station just a few metres below
- ) The only good thing that can be said about this cladded building now coming with an extra two ugly toppings, is the local fire station is only a few minutes away. I bet there aren't any sprinklers specified.
- ) Merton Ventures Ltd, that the building could not be developed, as proposed, because it is directly above the tube line, and this presented structural problems

#### Other

- ) Pressure on the service management company and services in the building.
- ) There is only one small lift in the building and limited refuse storage which are already overstretched.
- ) obviously planned by the developers before the building was first built recently possibly to avoid failing to get the original planning permission possibly due to the excessive height and also to avoid paying for or having to provide affordable housing in the original application.
- ) No increase in the capacity of the solar panels given the increased demand of energy 'The existing flat roof has a number of solar panels which will be decommissioned and reinstalled once the upper extension is completed.'
- ) Hours of work controlled
- ) The refuse room is already at capacity
- ) No provision for affordable housing
- ) 15 flats are currently serviced by one lift which provides access for disabled and elderly residents and visitors.
- ) Original development provided a roof garden for 15 flats, and a play space. The new design loses this roof garden for residents, and the play space
- ) Currently the flats have balconies within the building, ie, they do not project into airspace. However, the new plans show that the additional units would have balconies projecting into airspace, which would at that height not be safe for occupiers to use on a windy day.
- ) No contribution to biodiversity
- ) There is no parapet wall at roof level. For safety reasons and especially as plant will be located on the roof, this design is not appropriate
- ) In light of Grenfell are the developers seeking to replace the composite cladding on the rest of the building to a fire resistant

version? The council should use this opportunity to ensure the safety of all residents within the building.

### 5.3 Amendments

5.3.1 Following amendments to the scheme, 7 letters of objection received following a re-consultation with neighbours. The letters raise the following points:

- ) Original objections still stand
- ) how the extra floors could have a negative effect on the current underground infrastructure. The representative for TFL requested that mitigation of these potentialities be detailed however the applicant has not detailed how they intend to mitigate any of these.
- ) Unaesthetic and overbearing design
- ) Unfortunately, as the freehold owner is unresponsive to any requests to have these structural issues looked at, it would appear that approving this planning permission would be potentially dangerous.
- ) Layout and density of the building
- ) Effect on existing occupiers - Noise disturbance and dust
- ) Pressure on the service management company and services in the building
- ) Adequacy of parking/loading/turning and traffic generation
- ) Existing issues with the structural design of the building which are yet to be resolved
- ) The building is quite tall enough for the area
- ) View and skyline already has this grey and unattractive looking building exceeding the roofline of the properties towards the back of my property (those along Kingston Road). Adding another two storeys to this building, purely for the landlord to extract money from their existing property cannot justify the fact that my property will now have significantly reduced privacy, reduced sunlight and increased shade as well as the fact that my wife and I will forever have this building in our skyline.

### 5.4 Transport For London (2 separate letters received)

#### Letter 1

5.4.1 Though we have no objection in principle to the above planning application there are a number of potential constraints on the redevelopment of a site situated close to underground tunnels and infrastructure. It will need to be demonstrated to the satisfaction of LUL engineers that:

- ) the development will not have any detrimental effect on our tunnels and structures either in the short or long term
- ) the design must be such that the loading imposed on our tunnels or structures is not increased or removed
- ) we offer no right of support to the development or land

5.4.2 Therefore we request that the grant of planning permission be subject to conditions to secure the following:

The development hereby permitted shall not be commenced until detailed design, method statements and load calculations (in consultation with London Underground), have been submitted to and approved in writing by the local planning authority which:

- ) provide details on all structures
- ) accommodate the location of the existing London Underground structures and tunnels
- ) accommodate ground movement arising from the construction thereof
- ) and mitigate the effects of noise and vibration arising from the adjoining operations within the structures and tunnels.

The development shall thereafter be carried out in all respects in accordance with the approved design and method statements, and all structures and works comprised within the development hereby permitted which are required by the approved design statements in order to procure the matters mentioned in paragraphs of this condition shall be completed, in their entirety, before any part of the building hereby permitted is occupied.

Reason: To ensure that the development does not impact on existing London Underground transport infrastructure, in accordance with London Plan 2015 Table 6.1, draft London Plan policy T3 and 'Land for Industry and Transport' Supplementary Planning Guidance 2012

5.4.3 We also ask that the following informative is added:

The applicant is advised to contact London Underground Infrastructure Protection in advance of preparation of final design and associated method statements, in particular with regard to: demolition; drainage; excavation; and construction methods;

This response is made as Railway Infrastructure Manager under the "Town and Country Planning (Development Management Procedure) Order 2015". It therefore relates only to railway engineering and safety

matters. Other parts of TfL may have other comments in line with their own statutory responsibilities.

## **Letter 2**

- 5.4.4 The site of the proposed development is on Milner Road and located less than 87 metres from the A219 Morden Road, which forms part of the Strategic Road Network (SRN). TfL has a duty under the Traffic Management Act 2004 to ensure that any development does not have an adverse impact on the SRN.
- 5.4.5 The site has a Public Transport Access Level (PTAL) of 6a, on a scale ranging from 0 to 6b, where 6b represents the greatest level of access to public transport services. The site has access to 8 bus services within a 7 minute walk from the site. The site has access to 1 tram station within a 2 minute walk from the site. The site has access to 6 rail stations. The nearest London Underground station is South Wimbledon. Considering the sites high PTAL TfL welcomes the proposal of a car free development to ensure active travel.
- 5.4.6 The applicant proposes providing 8 cycle parking spaces. This is not in line with the minimum cycle parking standards set out in the draft London Plan. TfL requests that the applicant provide at least 9 long stay and 2 short stay cycle parking spaces. A The applicant should ensure all cycle parking provision meets London Cycle Design Standards (LCDS).
- 5.4.7 TfL request that the applicant provides us with a Construction Logistics Plan
- A How delivery vehicles are going to enter and exit the site.
  - B Wheel washing facilities to ensure safety on the road.
  - C Banksmen introduced to ensure safety on the road for vehicles entering and exiting the site.
  - D Vehicle arrivals to be scheduled and managed by the site manager ensuring that delivery vehicles come in when they are expected and on time making sure that the site is free from any delays or missed communication.
- 5.4.8 TfL request that delivery and servicing of the site are not carried out in the peak hours of 7:30-9:30am and 17:00-18:00pm. This is in the interests of road safety and in line with the Mayors Vision Zero Targets.
- 5.4.9 TfL recommend that the applicant delivers a Delivery and Servicing Plan in accordance with vehicles loading/unloading restrictions. In addition, TfL request that the applicant produces a Traffic Management Plan to ensure safety on the road in line with the Mayors Vision Zero targets for 2041.

5.4.10 It is requested that the applicant uses FORS and CLOCS registered vehicles for all construction and delivery vehicles serving the site. However, the Mayor is in the process of implementing more stringent Direct Vision Standards (DVS) across London starting in October 2020. The applicant should make sure that all vehicles comply with the DVS standards also.

A An idle vehicle route should be provided, showing where delivery vehicles can wait should there be no space at site for offloading

B TfL request that a delivery bay is put in place where delivery vehicles can go to avoid any congestion and to improve road safety.

5.4.11 Any hoarding for the proposed development would be subject to a separate Section 172 Licence application under the Highways Act 1980 to the Asset Operations team at TfL.

5.4.12 The footway and carriageway of Milner Road must not be blocked during the installation works. Temporary obstructions during the installation works must be kept to a minimum and should not encroach on the clear space needed to provide safe passage to pedestrians or obstruct the flow of traffic on Milner Road.

5.4.13 All vehicles associated with the installation works must only park/stop at permitted locations and within the time periods permitted by existing on street restrictions.

## 6. **POLICY CONTEXT**

6.1 The relevant policies within Merton's Sites and Policies Plan (2014) are:

DM D2 Design considerations in all development  
DM D3 Alterations and extensions to existing buildings  
DM D4 Managing heritage assets  
DM EP2 Reducing and mitigating noise  
DM EP3 Allowable solutions  
DM EP4 Pollutants  
DM T2 Transport impact of development  
DM T3 Car parking and servicing standards  
DM H2 Housing Mix

6.2 The relevant policies within the Merton Core Planning Strategy (July 2011) are:

CS 8 Housing Provision  
CS 14 Design,  
CS 15 Climate change,  
CS 18 Active transport  
CS 19 Transport  
CS 20 Parking, Servicing & Delivery

6.3 The relevant policies within the London Plan (July 2016) are:

5.1 Climate change mitigation  
5.3 Sustainable Design and Construction  
5.7 Renewable energy  
6.9 Cycling  
6.10 Walking  
6.13 Parking  
7.3 Designing out crime  
7.4 Local character  
7.5 Public realm  
7.6 Architecture  
7.15 Reducing and managing noise, improving and enhancing the acoustic environment and promoting appropriate soundscapes  
8.2 Planning obligations  
8.3 Community infrastructure levy

6.4 Other

) National Planning Policy Framework 2019  
) National Planning Practice Guidance 2014  
) Planning and Compulsory Purchase Act – 2004  
) Draft London Plan 2019  
) Draft Local Plan 2020

## 7. **PLANNING CONSIDERATIONS**

7.1.1 The principal planning considerations in this case are: the principle of development, the design of the proposed extension, impact on the character and appearance of the existing building, street scenes, standard of residential accommodation, impact on neighbouring amenity and parking/traffic considerations.

### 7.2 **Amendments**

7.2.1 The proposed extension has been reduced in size, now being inset away from the building elevations below and thus a reduction in the number of flats from 6 to 5. The materials of the extension have also be changed to

matching grey colour panels (only one shade), a zinc frame and additional glazing to ensure that the extension respects the original design approach for the building.

### **7.3 Principle of Development**

- 7.3.1 Section 38(6) of the Planning and Compulsory Purchase Act 2004 states that when determining a planning application, regard is to be had to the development plan, and the determination shall be made in accordance with the development plan, unless material considerations indicate otherwise.
- 7.3.2 NPPF - Paragraph 122 explains planning decisions should support development that makes efficient use of land, taking into account the identified need for different types of housing and other forms of development, and the availability of land suitable for accommodating it; the desirability of maintaining an area's prevailing character and setting, and the importance of securing well-designed, attractive and healthy places.
- 7.3.3 NPPF Paragraph 123 states that it is especially important that planning decisions avoid homes being built at low densities, and ensure that developments make optimal use of the potential of each site. The National Planning Policy Framework 2019 and London Plan policies 3.3 & 3.5 promote sustainable development that encourages the construction of additional dwellings at locations with good public transport accessibility.
- 7.3.4 Policy 3.3 of the London Plan states that development plan policies should seek to identify new sources of land for residential development including intensification of housing provision through development at higher densities.
- 7.3.5 Core Strategy policies CS8 & CS9 seek to encourage proposals for well-designed and conveniently located new housing that will create socially mixed and sustainable neighbourhoods through physical regeneration and effective use of space.
- 7.3.6 Merton's overall housing target between 2011 and 2026 is 5,801 dwellings (Authority's Monitoring Report Draft 2017/19, p12). The latest (draft) Monitoring report confirms:
- ) All the main housing targets have been met for 2017/18.
  - ) 665 additional new homes were built during the monitoring period, 254 above Merton's target of 411 new homes per year (London Plan 2015).
  - ) 2013-18 provision: 2,686 net units (813 homes above target)

) For all the home completions between 2004 and 2017, Merton always met the London Plan target apart from 2009/10. In total Merton has exceeded the target by over 2,000 homes since 2004.

- 7.3.7 While a robust five years supply has been achieved in Merton, the housing need is increasing in London. The borough's Core Planning Strategy states that that it is expected that the delivery of new residential accommodation in the borough will be achieved in various ways including development in 'sustainable brownfield locations' and "ensuring that it is used efficiently" (supporting text to Policy CS9). The application site is on brownfield land and is in a sustainable location adjacent to other existing residential properties.
- 7.3.8 Table 3.1 of the London Plan identifies that LBM has an annual housing target of 411 units, or 4,107 over the next ten years. However, this minimum target is set to increase significantly to 918 set out in the 'London Plan Examination in Public Panel Report Appendix: Panel Recommendations October 2019', and which is expected to be adopted later this year. This significant increase will require a step change in housing delivery within the LBM.
- 7.3.9 The application seeks to create 5 residential units which will make a small contribution to meeting housing targets and would provide a mix of unit sizes that will assist in the delivery of a mixed and balanced community in a sustainable location. New housing is considered to be in accordance with the objectives of the NPPF, London Plan targets, and LBM policies.

#### 7.4 **Design**

- 7.4.1 Planning policy DM D2 (Design considerations in all development) of Merton's Site and Polices Plan 2014 requires all development to relate positively and appropriately to the siting, rhythm, scale, density, proportions, heights, materials and massing of surrounding buildings and existing street patterns, historic context, urban layout and landscape features of the surrounding area.
- 7.4.2 It has to be noted that the existing buildings cladding panel are not the best quality and has been extremely poorly fixed to the building with a range of different sized gaps between panels. The works would have had to comply with building control regulations. Unfortunately the Council has no power to rectify the poor workmanship. However, officers have raised the poor quality of the cladding with the applicant (not the original developer) and have been advised that the applicant is looking into the existing cladding situation. The extensive use of small sized and different coloured grey panels throughout the whole building, in officer's opinion also detracts from the overall design quality of the building. Following long



discussions with the applicant, officers are now consent that the proposed extension seeks to enhance the buildings design.

- 7.4.3 The proposals seek to extend a recently completed building with two additional floors upwards. Following amendments, officers are now in a position where they can support the design of the proposed extension. The extension is now considered to of an appropriate scale, mass and detail that would respect the original building. The use of a part zinc frame will give the extension a floor focal point and a defined top to the building, something the existing building failed to successfully deliver. The proposed use of larger panels in only one grey shade (rather than a mix of shades as per existing) will help create a more subtle addition to the top of the building and one that would respects the original design approach.
- 7.4.4 The proposal does seek to increase the height of an already large building. Merton's Tall Building Background paper (2010) advises that tall buildings are generally not appropriate within the borough due to its predominantly suburban low rise character. Tall buildings may be suitable where all of the following factors are present:
- ) Good public transport accessibility (the site benefits from good public transport accessibility);
  - ) Existing higher building precedent (both the Council and Planning Inspectorate have in recent years endorsed proposals for the refurbishment and extension of Spur House the height of which significantly exceeds suburban housing, medium sized blocks of flats and mixed commercial and residential buildings in the area);
  - ) Regeneration or change is envisaged (Merton Priory Homes are carrying out consultation in relation to the regeneration and potential intensification of development on the nearby High Path estate).
- 7.4.5 In addition to the above, the increased height of the building is not considered to be excessive following amendments to the design of the extension with more glazing and the extension now being inset from all edges of the building. The inseting of the extension away from the floor below will greatly help reduce the dominance of the extension, particularly when viewed from street level and neighbouring properties close to the application site. From longer views the proposed extension would appear as a subordinate element, giving the building an integrated top floor design. Similar to the approach at Spur House.
- 7.4.6 In regards to the impact on the adjacent Grade II listed South Wimbledon underground station, the proposed extension is considered to respect the existing building and the context of the site. There would be a good level of separation between the proposed extension and the station to ensure

that the proposal respects the listed building so that its design and setting is preserved.

## **7.5 Neighbour Amenity**

- 7.5.1 London Plan policies 7.6 and 7.7, CS policy 14, and SPP policy DM D2 seek to ensure new developments do not unacceptably impact on the amenities of the occupiers of any adjoining and nearby surrounding properties. Planning policy DM D2 (Design considerations in all developments) states that amongst other planning considerations that proposals will be expected to ensure provision of appropriate levels of sunlight and daylight, quality of living conditions, amenity space and privacy, to both proposed and adjoining buildings and gardens.
- 7.5.2 The applicant has submitted an independent sun and day light report by Right of Light Consulting. The report states that all neighbouring windows pass the relevant BRE diffuse daylight and direct sunlight tests. The development also passes the BRE overshadowing to gardens and open spaces test. In summary, the numerical results in this study demonstrate that the proposed development will have a low impact on the light receivable by its neighbouring properties. The report therefore concludes that the proposed development sufficiently safeguards the daylight and sunlight amenity of the neighbouring properties.
- 7.5.3 The size and massing of the extension has been reduced in size compared to the original design. Other than the modest sized liftshaft and staircase area at the rear of the building, the proposed extension would be inset from all building elevations below. This would ensure that the proposed flats would have restricted downward view of surrounding residential properties and gardens.
- 7.5.4 From the majority of neighbouring residential units close to the application site, the proposed extension would not be clearly visible as it would be inset away from the elevation. Therefore in these instances the proposed extension would have no greater impact than the current situation. Where the extension would be visible from other surrounding residential properties, there would be a good level of separation to ensure that there would be no undue loss of amenity.
- 7.5.5. Some objections from Spur House have raised concerns that the extension would restrict views from existing flats. For the vast majority of the flats in Spur House, the proposed the proposed extension would not be clearly visible. The extension would be visible from some of the upper level flats, views are not protected and given the good level of separation between the application site and Spur House there would be no undue loss of amenity.

7.5.6 The proposed extension would be located on top of existing flats. Matters relating to noise transfer would be covered outside planning under building control regulations.

## 7.6 **Standard of Residential Accommodation**

7.6.1 London Plan policies 3.5, 3.6, 3.7 & 3.8, CS policy CS 14, and SPP policies DM D1 and DM D2 seek to ensure that new residential development is of a high standard of design both internally and externally and provides accommodation capable of adaptation for an ageing population and for those with disabilities, whilst offering a mix of unit size reflective of local need.

7.6.2 Planning policy CS 14 (Design) of Merton's Core planning Strategy seeks to encourage well designed housing in the Borough by ensuring that all residential development complies with the most appropriate minimum space standards. The most up-to-date standards are the housing standards, minor alterations to the London Plan (March 2016).

7.6.3 In terms of the quality of the accommodation proposed, it is considered that the proposed flats would provide a satisfactory standard of accommodation for future occupiers. The proposed flats would exceed/meet minimum London Plan Gross Internal Area and room sizes. The studio flat would fail just below (0.6smq) the minimum amenity space standards, however all other flats would exceed minimum standards. The shortfall in the minimum standard of the studio flat is unfortunate, however given the constraints of the site this has not been possible. It should also be noted that the shortfall is only marginal and relates to a studio flat where it is not uncommon for this type of accommodation to have no access to private amenity space. The shortfall in amenity space standard is not considered to warrant refusal of planning permission. All flats would be dual aspect and each habitable room would receive suitable light levels and adequate outlook.

### Housing mix

7.6.4 Planning policy DM D2 (Housing Mix) seeks to create socially mixed communities, catering for all sectors of the community by providing a choice of housing with respect to dwelling size and type in the borough. London Plan Policy 3.8, seeks to promote housing choice and seek a balance mix of unit sizes in new developments, with particular focus on affordable family homes. Family sized accommodation is taken in the London Plan and LBM policy to include any units of two bedrooms or more.

- 7.6.5 The borough level indicative proportions concerning housing mix (as set out below) will be applied having regard to relevant factors including individual site circumstances, site location, identified local needs, economics of provision such as financial viability and other planning contributions.

*Table in Planning policy DM D2 (Housing Mix) of Merton's Sites and policies plan 2014*

Number of Bedrooms	Percentage of units
One	33%
Two	32%
Three +	35%

Proposal – 2 x studio 2 x 1 bed & 2 x 2 bed flats

Number of Bedrooms	Percentage of units
Studio/one	60%
Two	40%

- 7.6.6 The proposed housing mix of the site, whilst not meeting the Council percentage ratio set out in Policy DM H2 (Housing Mix), are only indicative targets. The proposal is a modest sized development where meeting housing mix targets is often problematic due to constraints of sites. The proposed housing mix would still offer 40% family type accommodation (2 bedroom or more) which is welcomed. Further, the site is close to a town centre location where smaller flats would likely be occupied by couples or independent people, who want good access to the town centre amenities and public transport. The proposed flats are considered acceptable.

#### Bin and Recycling Storage

- 7.6.7 The proposal will provide 2 additional 1100l bins, 1 for general waste and 1 for mixed recycling in the existing bins store at ground floor level for the additional residents. The proposed level of bin storage is considered to be acceptable.

### **7.7 Highways**

- 7.7.1 The site is located within a CPZ and has a PTAL rating of 6a, indicating a very good level of accessibility to public transport. The amount of expected vehicle movements to and from the site and trip generation are likely to be low given the modest size of the development and therefore it is not anticipated that this would create adverse harm to traffic conditions in and around the area.

## Car

- 7.7.2 The development does not seek to provide any car parking spaces onsite. The proposed development would therefore be a car free development. The application site is located within an area of excellent public transport and given the existing pressures placed on existing Controlled Parking Zone (S1), in this instance it is considered that the development must be a permit free development. A permit free development would ensure that future occupiers of the flats would not be able to obtain a car parking permit for the CPZ. This both prompts sustainable modes of transport and does not place any additional pressure on the CPZ. The can be secured via a S106 agreement.

## Cycle

- 7.7.3 A new double stack cycle storage rack will be included in the existing cycle store to allow for an additional 12 cycles. The existing facility allows for 30 cycle spots for the original building a further 12 for the new flats will be accommodated within the existing cycle storage. Total of 42 cycle storage spaces will be provided. The proposed level of cycle storage is considered to be acceptable.

## Construction

- 7.7.4 As with any development there will be some impact on the local highway network during the construction process. In order to minimise impact upon the highway network and surrounding residential properties a planning conditions requiring details and approval of construction logistic can be secured via planning condition.

## 7.8 **Sustainability**

- 7.8.1 Planning policy CS15 (climate Change) of Merton's adopted Core Planning Strategy (2011) seeks to tackle climate change, reduce pollution, develop low carbon economy, consume fewer resources and use them more effectively.
- 7.8.2 Planning Policy 5.2 of the London Plan (2016) states that development proposals should make the fullest contribution to minimising carbon dioxide emissions in accordance with the following energy hierarchy:
1. Be lean: use less energy
  2. Be clean: supply energy efficiently
  3. Be Green: use renewable energy
- 7.8.3 The applicant has not submitted an energy statement, but the applicant

has been made aware of the sustainability requirements required in this instance. This will need to factor in the removal of the existing solar panels on the building's roof which would have to be removed to facilitate the proposed development. A planning condition requiring details to be submitted and approved by the Council would ensure that the development meets planning policy requirements.

## 7.9 Ecology

- 7.9.1 Given the constraints of the site, improving ecology on the site is problematic. As part of the original permission the building included a green roof. This would be lost as part of the proposed extension however this can be incorporated into the roof of the proposed extension. A planning condition requiring details of a green roof can be secured via planning condition. Additional design features such as bird boxes can ensure that the development makes some contribution towards ecology.

## 8 LOCAL FINANCIAL CONSIDERATIONS

- 8.1 The proposed development is liable to pay the Merton and Mayoral Community Infrastructure Levy (CIL), the funds for which will be applied by the Mayor towards the Crossrail project. Merton's Community Infrastructure Levy was implemented on 1<sup>st</sup> April 2014. This will enable the Council to raise, and pool, contributions from developers to help pay for things such as transport, decentralised energy, healthcare, schools, leisure and public open spaces - local infrastructure that is necessary to support new development. Merton's CIL has replaced Section 106 agreements as the principal means by which pooled developer contributions towards providing the necessary infrastructure should be collected.

## 9. SUSTAINABILITY AND ENVIRONMENTAL IMPACT ASSESSMENT REQUIREMENTS

- 9.1 The application does not constitute Schedule 1 or Schedule 2 development. Accordingly, there are no requirements in terms of EIA submission.

## 10. CONCLUSION

- 10.1 The proposed development would create 5 new flats which would make a small contribution towards housing targets which is welcomed. The design of the extension is considered to respect the existing building and context of the site (both existing and emerging). The proposal would provide good quality residential units with no undue impact upon neighbouring amenity or highway conditions. The application would therefore be recommended

for approval by planning officers subject to conditions and S106 deed of variation agreement relating to permit free development.

## **RECOMMENDATION**

### GRANT PLANNING PERMISSION

Subject to the completion of a Section 106 Agreement covering the following heads of terms:-

1. Designation of the development as permit-free and that onstreet parking permits would not be issued for future residents of the proposed development.
2. The developer agreeing to meet the Councils costs of preparing, drafting and monitoring the Section 106 Obligations.

And the following conditions:

1. A.1 Commencement of Development
2. A7 Approved Plans
3. B.1 Materials to be approved
4. Refuse implementation
5. Cycle implementation
6. D11 Construction Times
7. No use of flat roofs
8. Sustainability
9. Green Roof & Ecology
- 10 Construction Logistics Plan  
A How delivery vehicles are going to enter and exit the site.  
B Wheel washing facilities to ensure safety on the road.  
C Banksmen introduced to ensure safety on the road for vehicles entering and exiting the site.

D Vehicle arrivals to be scheduled and managed by the site manager ensuring that delivery vehicles come in when they are expected and on time making sure that the site is free from any delays or missed communication

- 11 The development hereby permitted shall not be commenced until detailed design, method statements and load calculations (in consultation with London Underground), have been submitted to and approved in writing by the local planning authority which:
- provide details on all structures
  - accommodate the location of the existing London Underground structures and tunnels
  - accommodate ground movement arising from the construction thereof
  - and mitigate the effects of noise and vibration arising from the adjoining operations within the structures and tunnels.

The development shall thereafter be carried out in all respects in accordance with the approved design and method statements, and all structures and works comprised within the development hereby permitted which are required by the approved design statements in order to procure the matters mentioned in paragraphs of this condition shall be completed, in their entirety, before any part of the building hereby permitted is occupied.

Reason: To ensure that the development does not impact on existing London Underground transport infrastructure, in accordance with London Plan 2015 Table 6.1, draft London Plan policy T3 and 'Land for Industry and Transport' Supplementary Planning Guidance 2012

12. Delivery and Servicing Plan - TfL request that delivery and servicing of the site are not carried out in the peak hours of 7:30-9:30am and 17:00-18:00pm.
13. Traffic Management Plan

#### Planning Informative

1. The applicant is advised to contact London Underground Infrastructure Protection in advance of preparation of final design and associated method statements, in particular with regard to: demolition; drainage; excavation; and construction methods;



This response is made as Railway Infrastructure Manager under the "Town and Country Planning (Development Management Procedure) Order 2015". It therefore relates only to railway engineering and safety matters. Other parts of TfL may have other comments in line with their own statutory responsibilities.

2. To be included in transport planning conditions where relevant. TfL requests that the applicant uses FORS and CLOCS registered vehicles for all construction and delivery vehicles serving the site. However, the Mayor is in the process of implementing more stringent Direct Vision Standards (DVS) across London starting in October 2020. The applicant should make sure that all vehicles comply with the DVS standards also.

A An idle vehicle route should be provided, showing where delivery vehicles can wait should there be no space at site for offloading  
B TfL request that a delivery bay is put in place where delivery vehicles can go to avoid any congestion and to improve road safety.

The footway and carriageway of Milner Road must not be blocked during the installation works. Temporary obstructions during the installation works must be kept to a minimum and should not encroach on the clear space needed to provide safe passage to pedestrians or obstruct the flow of traffic on Milner Road.

All vehicles associated with the installation works must only park/stop at permitted locations and within the time periods permitted by existing on street restrictions.

3. Any hoarding for the proposed development would be subject to a separate Section 172 Licence application under the Highways Act 1980 to the Asset Operations team at TfL.

# NORTHGATE SE GIS Print Template

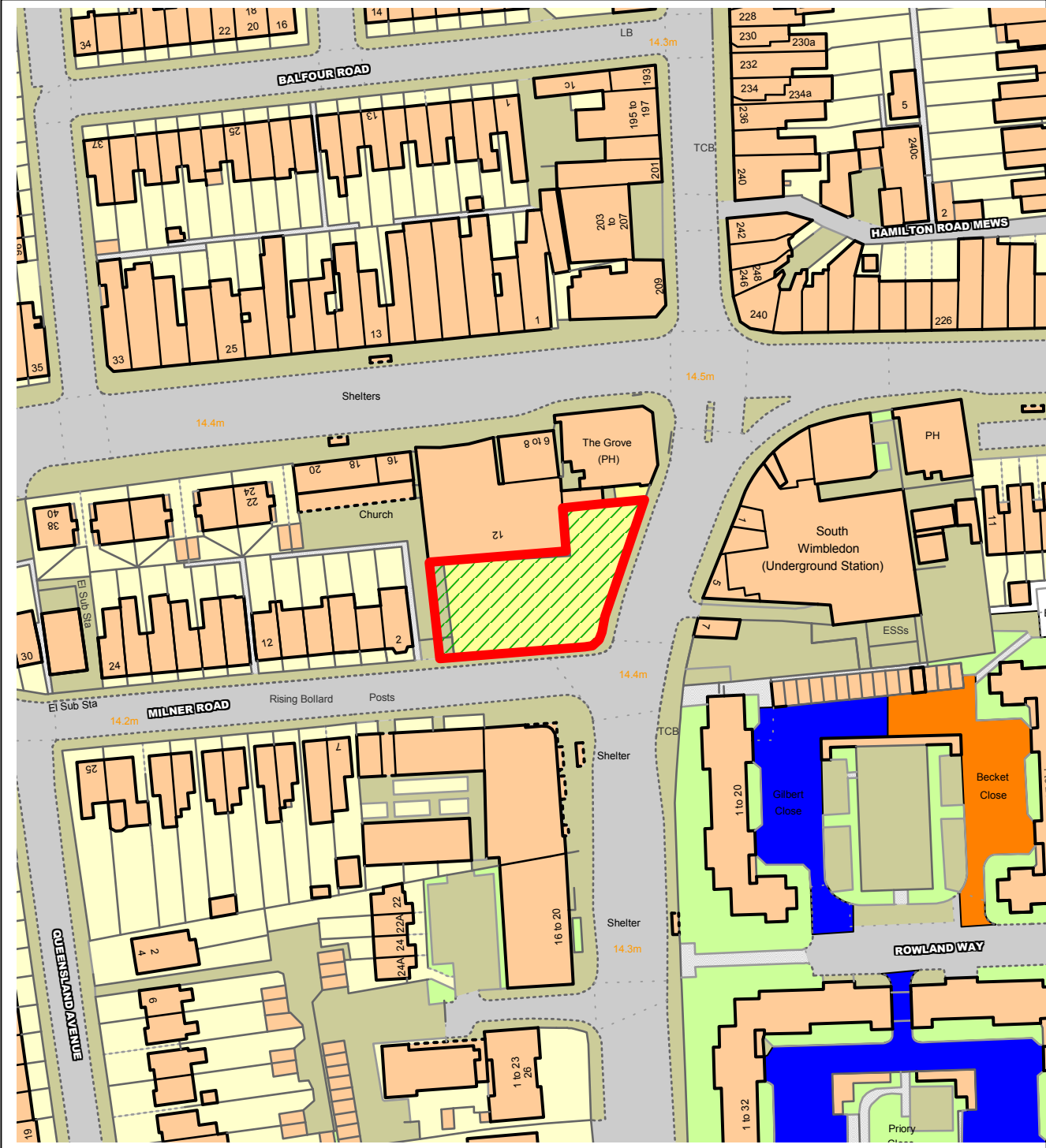

This material has been reproduced from Ordnance Survey digital map data with the permission of the controller of Her Majesty's Stationery Office, © Crown Copyright.

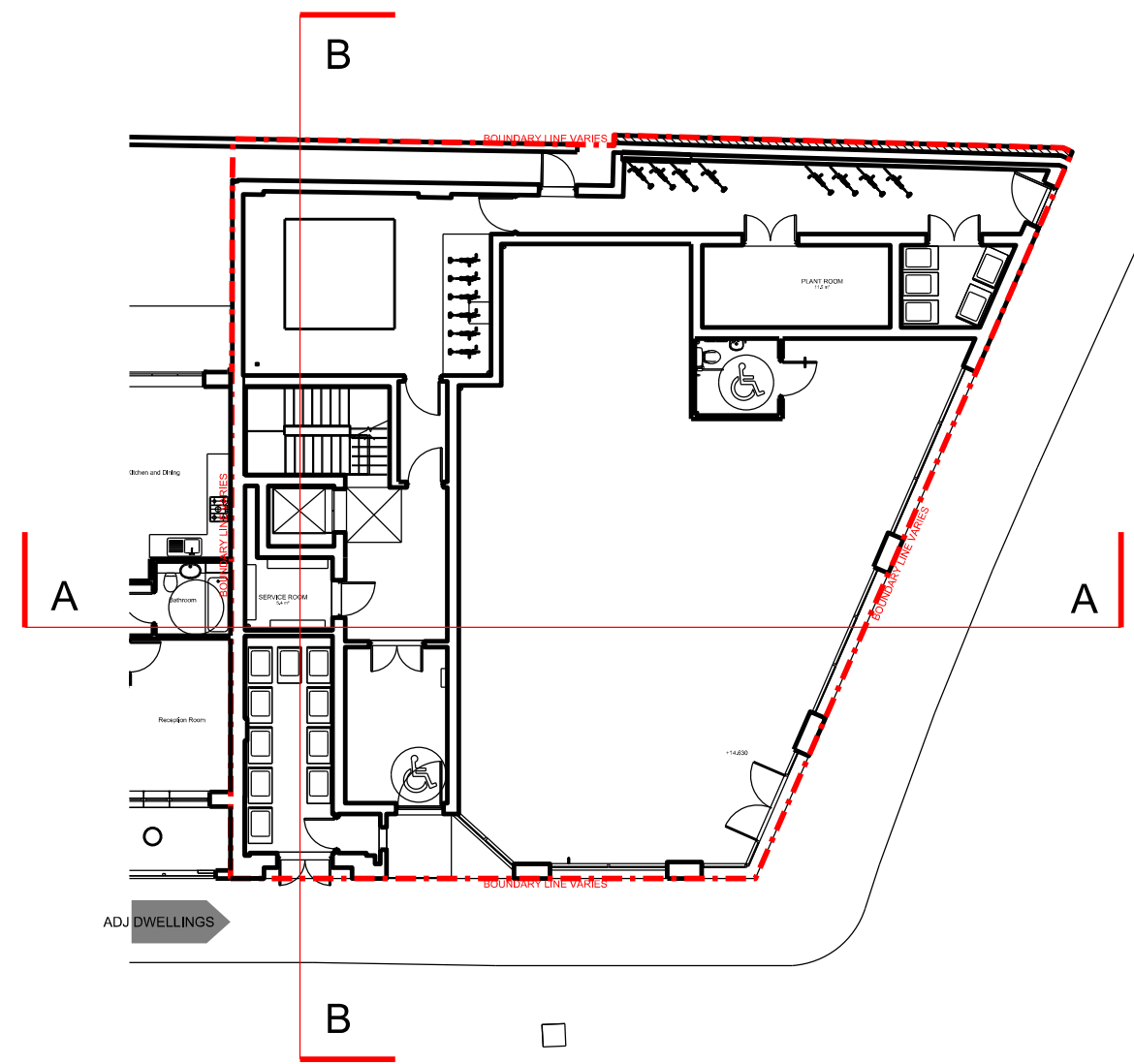

EXISTING GROUND FLOOR

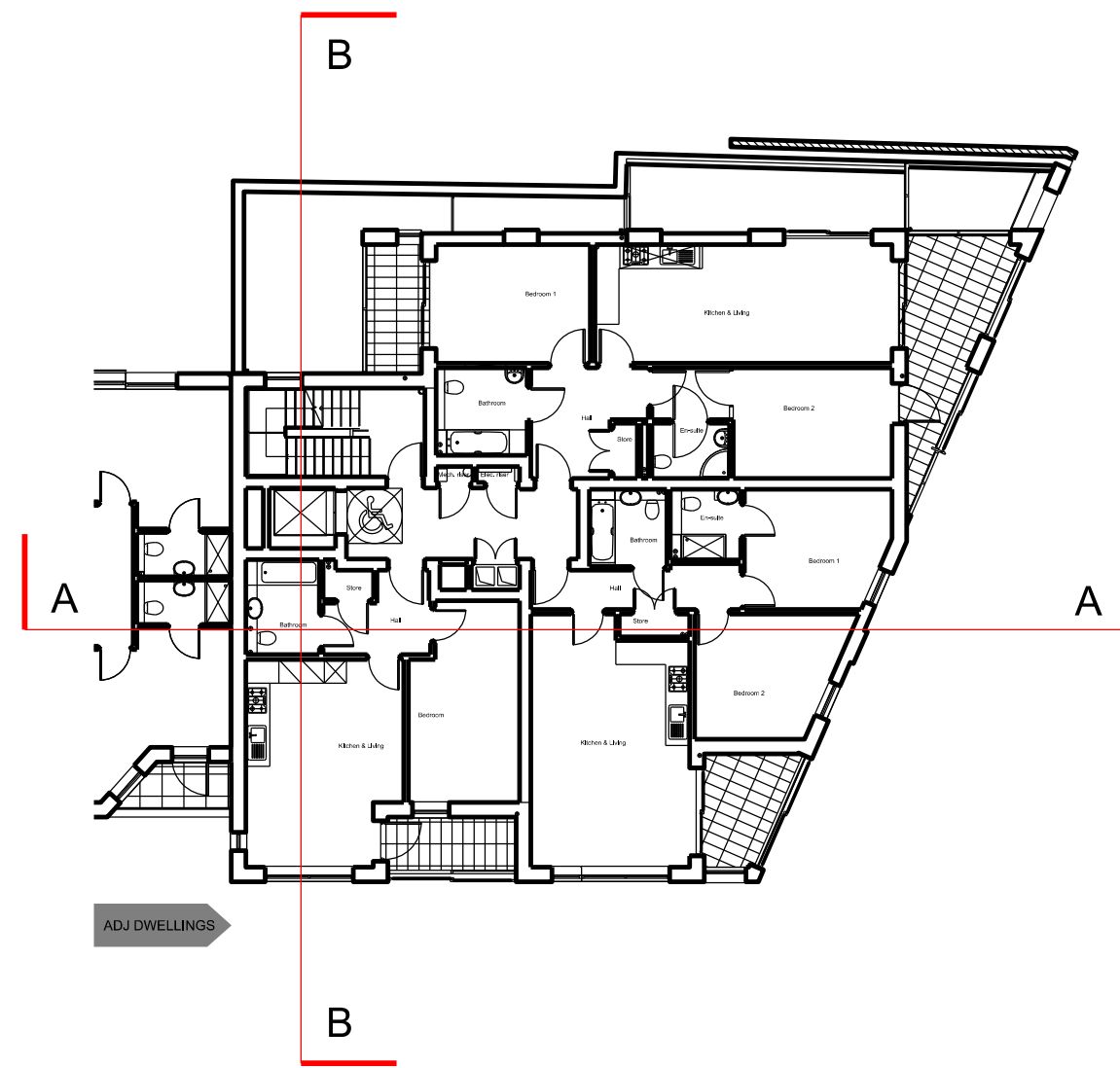

EXISTING FIRST FLOOR

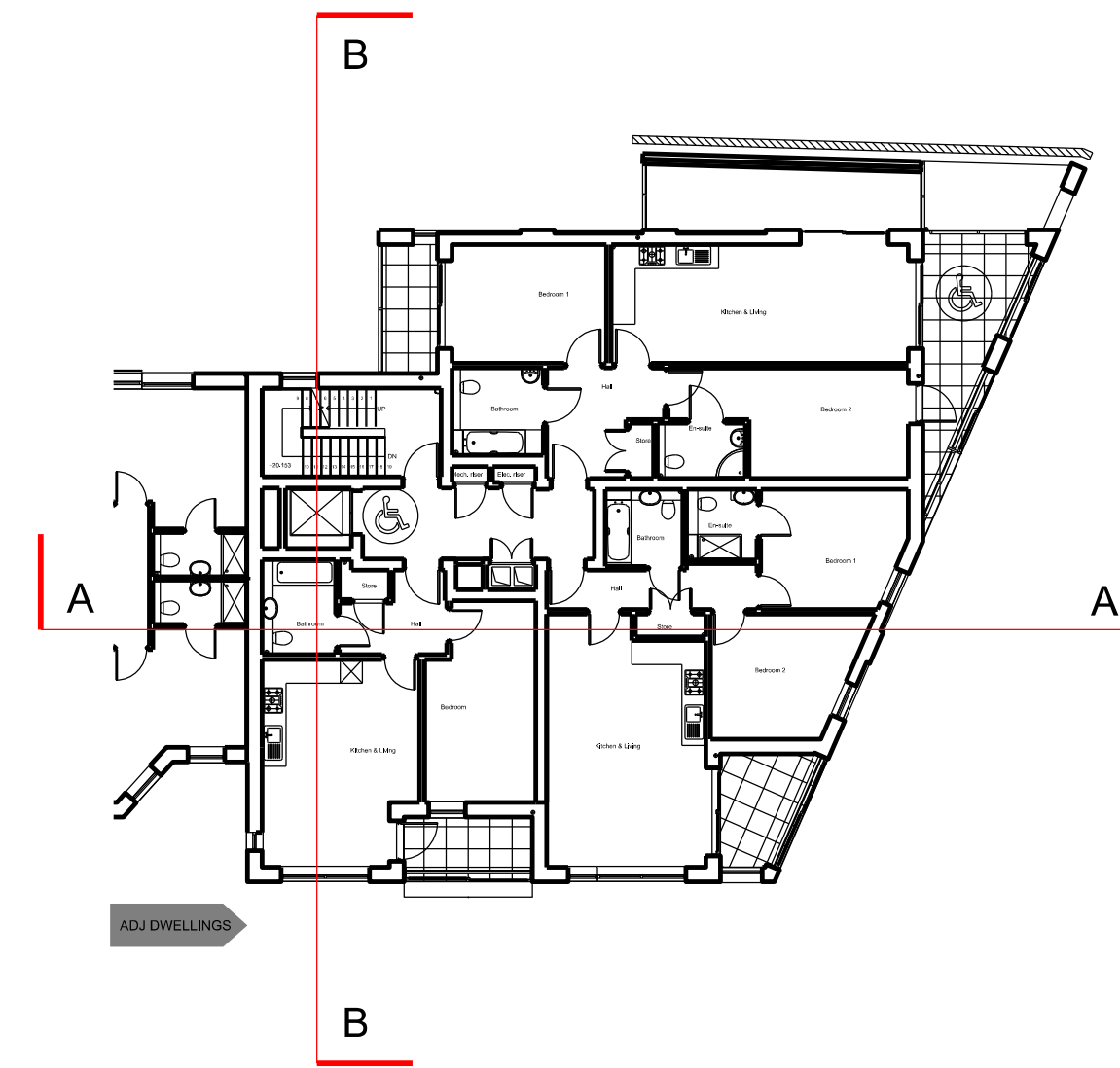

EXISTING SECOND FLOOR

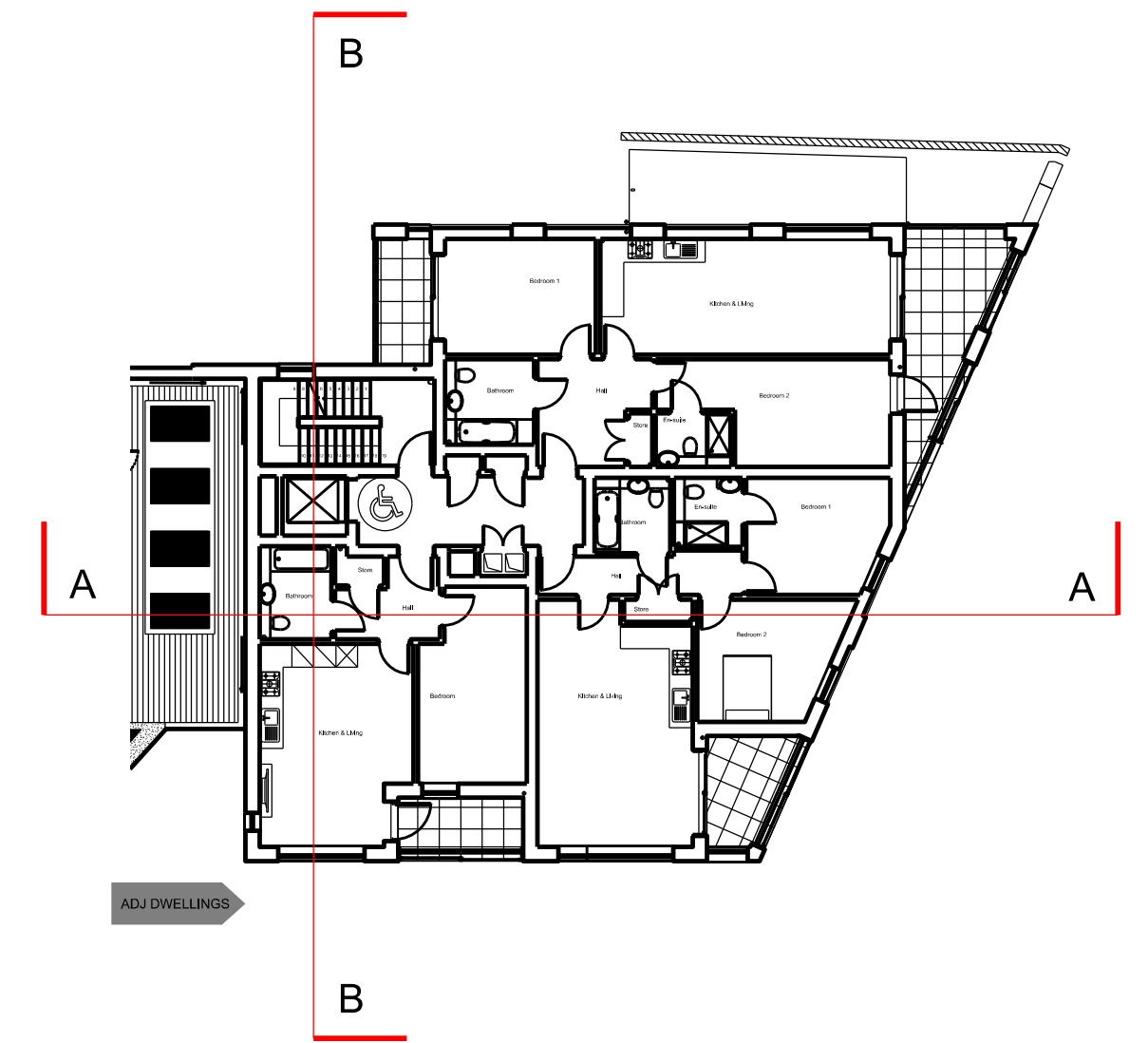

EXISTING THIRD FLOOR

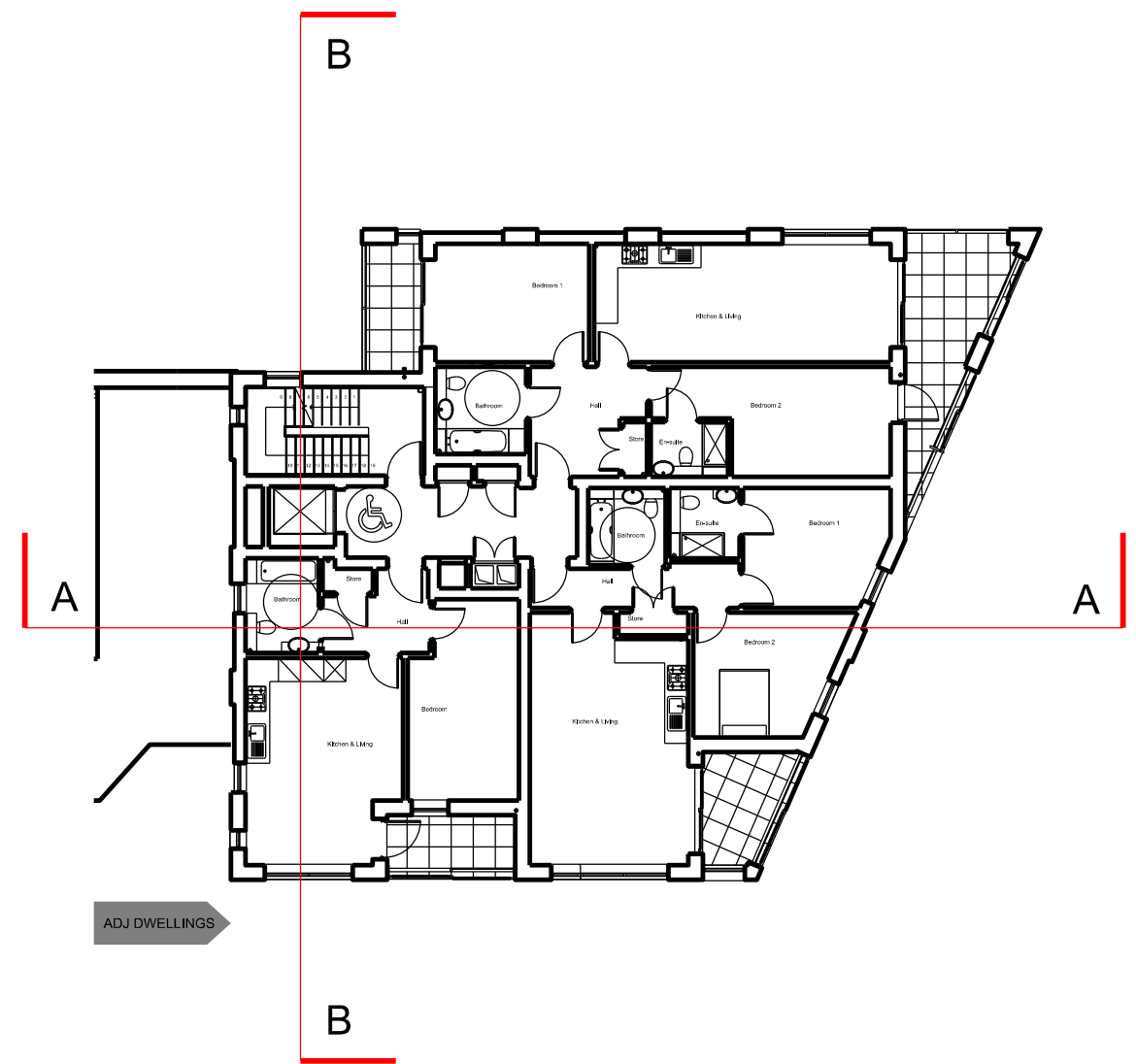

EXISTING FOURTH FLOOR

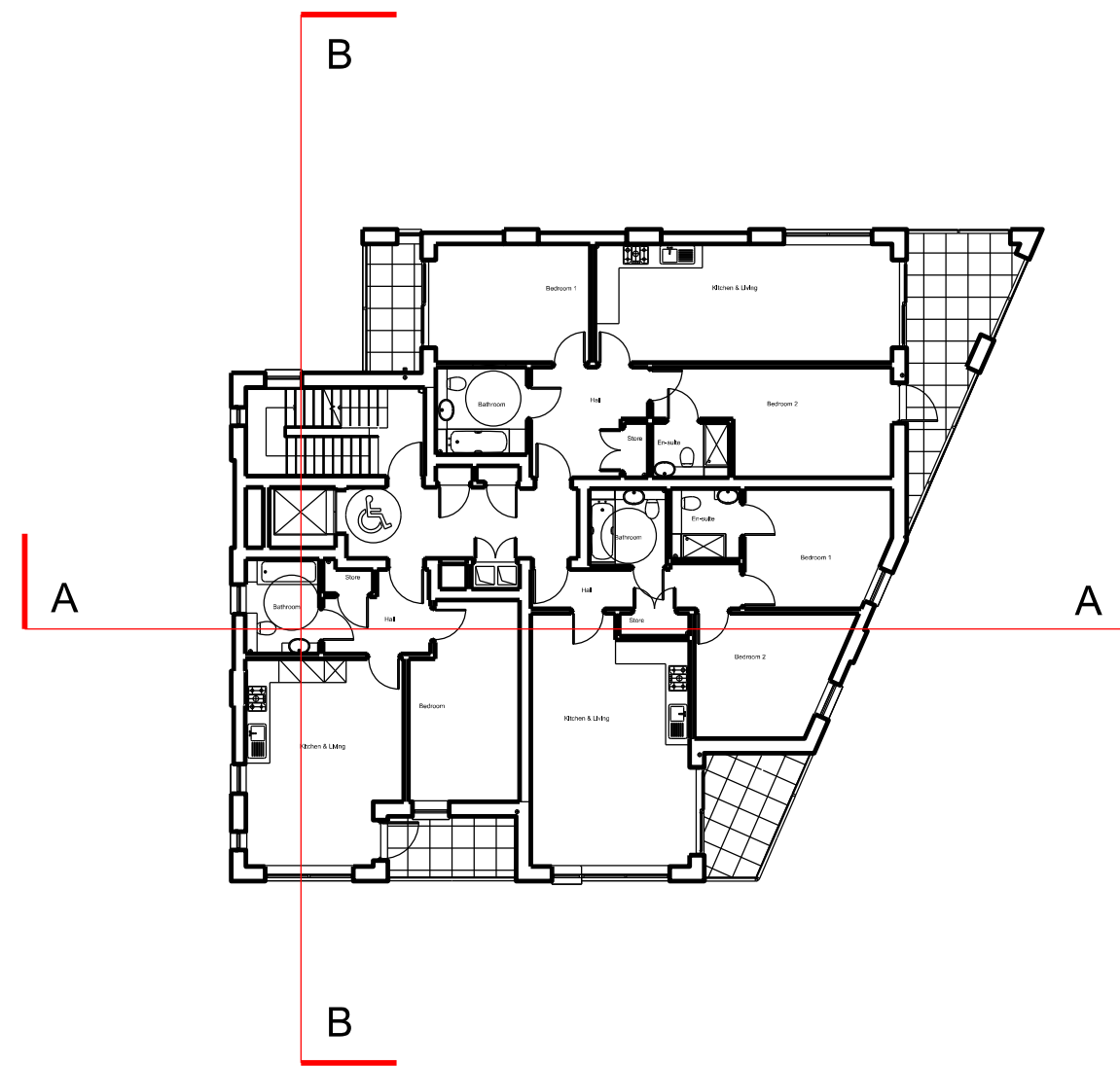

EXISTING FIFTH FLOOR

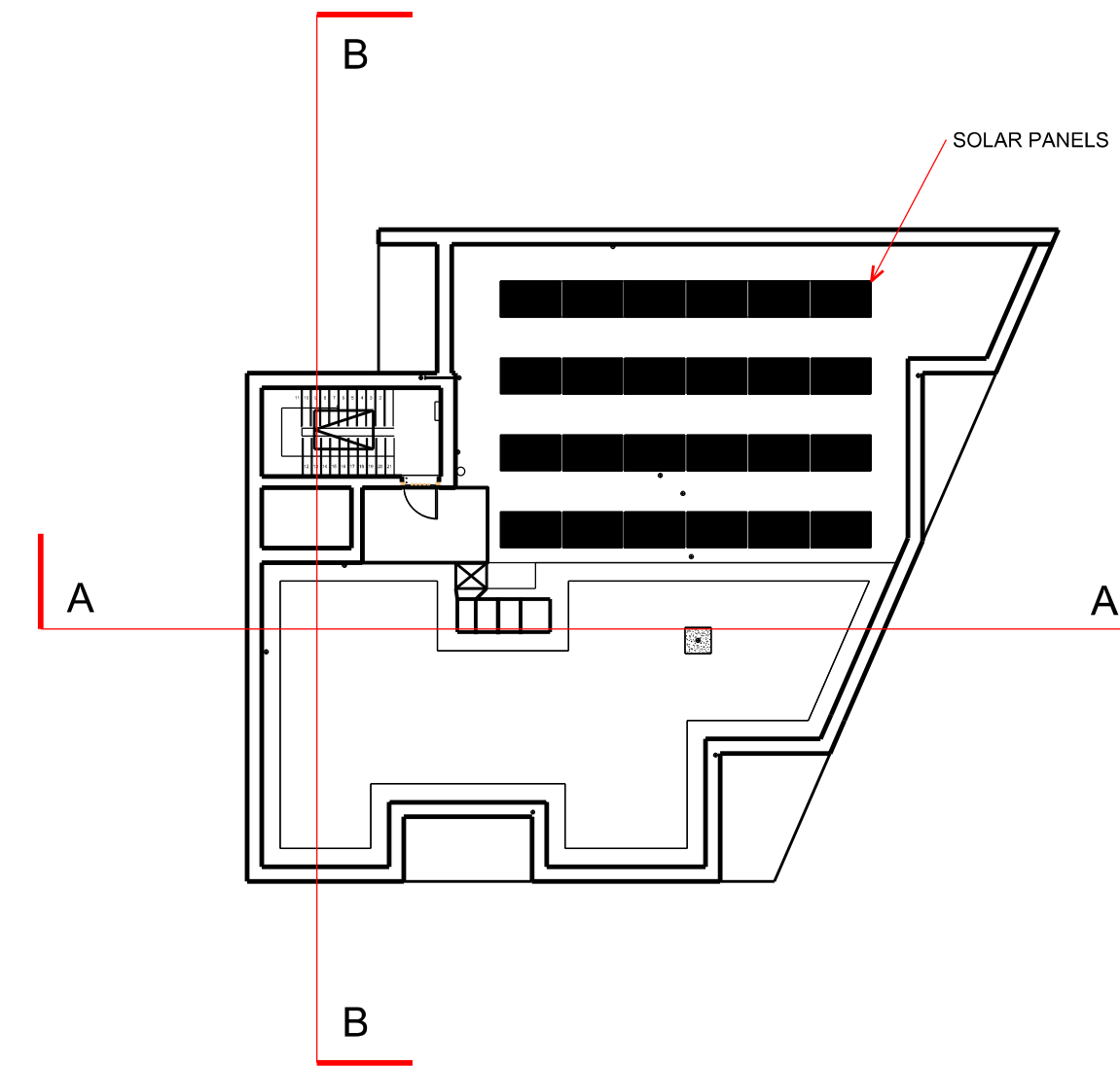

EXISTING ROOF OF STAIR CORE

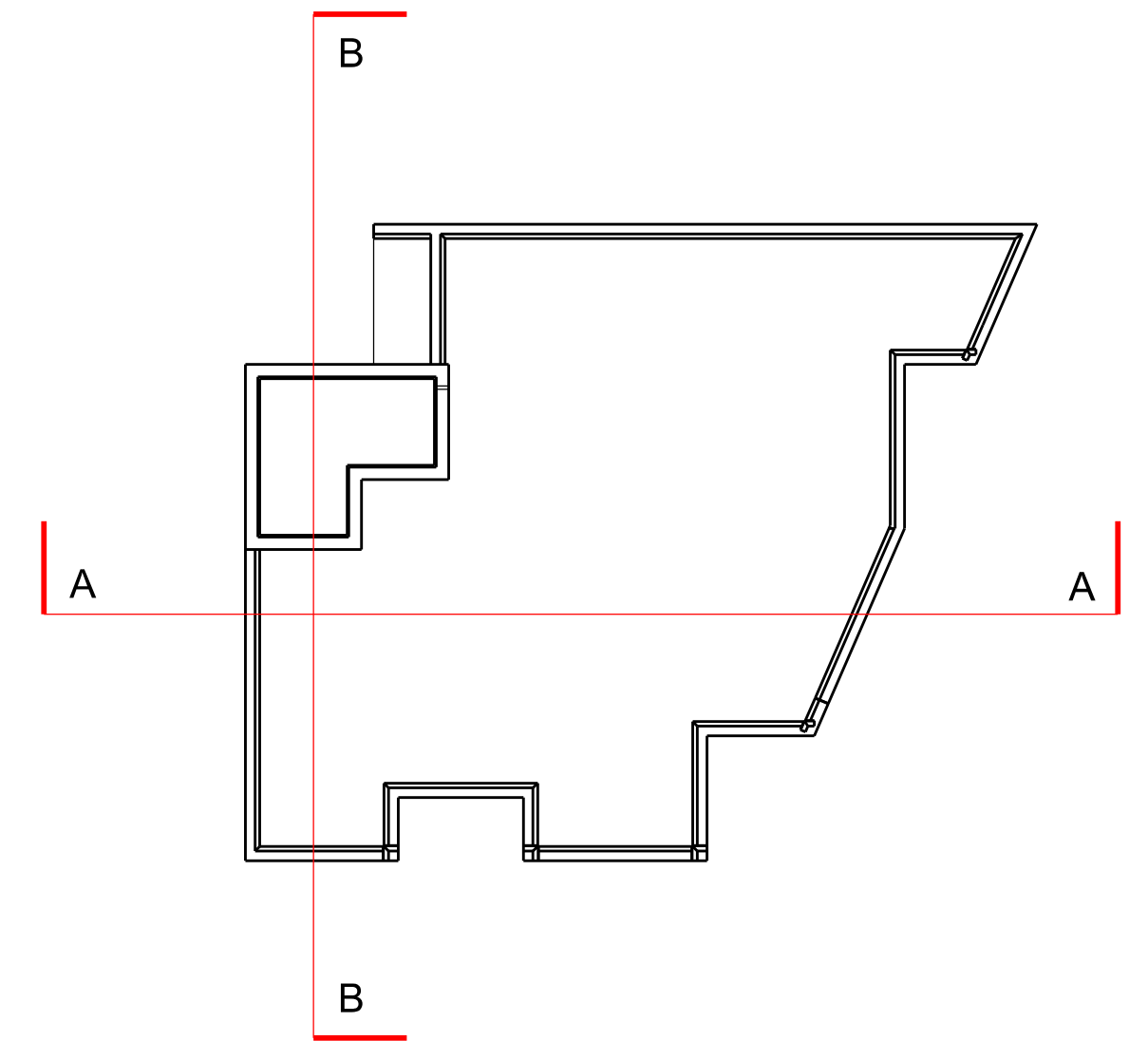

EXISTING ROOF LEVEL

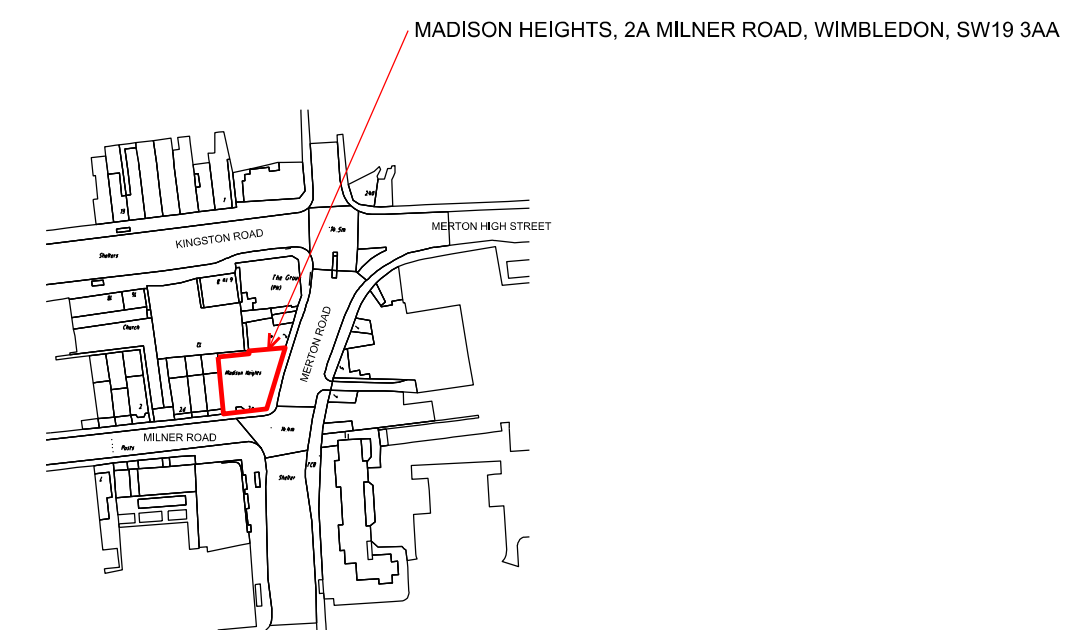

LOCATION MAP  
SCALE 1:1250

REVISION	DATE	COMMENTS	AUTHOR / CHECKED
DS SQUARED ARCHITECTS		MULTICOM HOUSE 2 SPRING VILLA ROAD EDGWARE LONDON HA8 7EB	
020 8732 5620		www.dssquared.co.uk	design@dssquared.co.uk
TITLE			
MADISON HEIGHTS, 2A MILNER ROAD, WIMLEDDON, SW19 3AA			
DETAIL			
EXISTING PLANS • LOCATION MAP			
DATE	SCALE	PAPER SIZE	AUTHOR / CHECKED
AUG 19	1:200; 1:1250	A1	KR/DS
DRAWING No.	REV.	STATUS	
18019 FP 01.01		FULL PLANNING	
SCALE BAR			
m	2	10	20 30





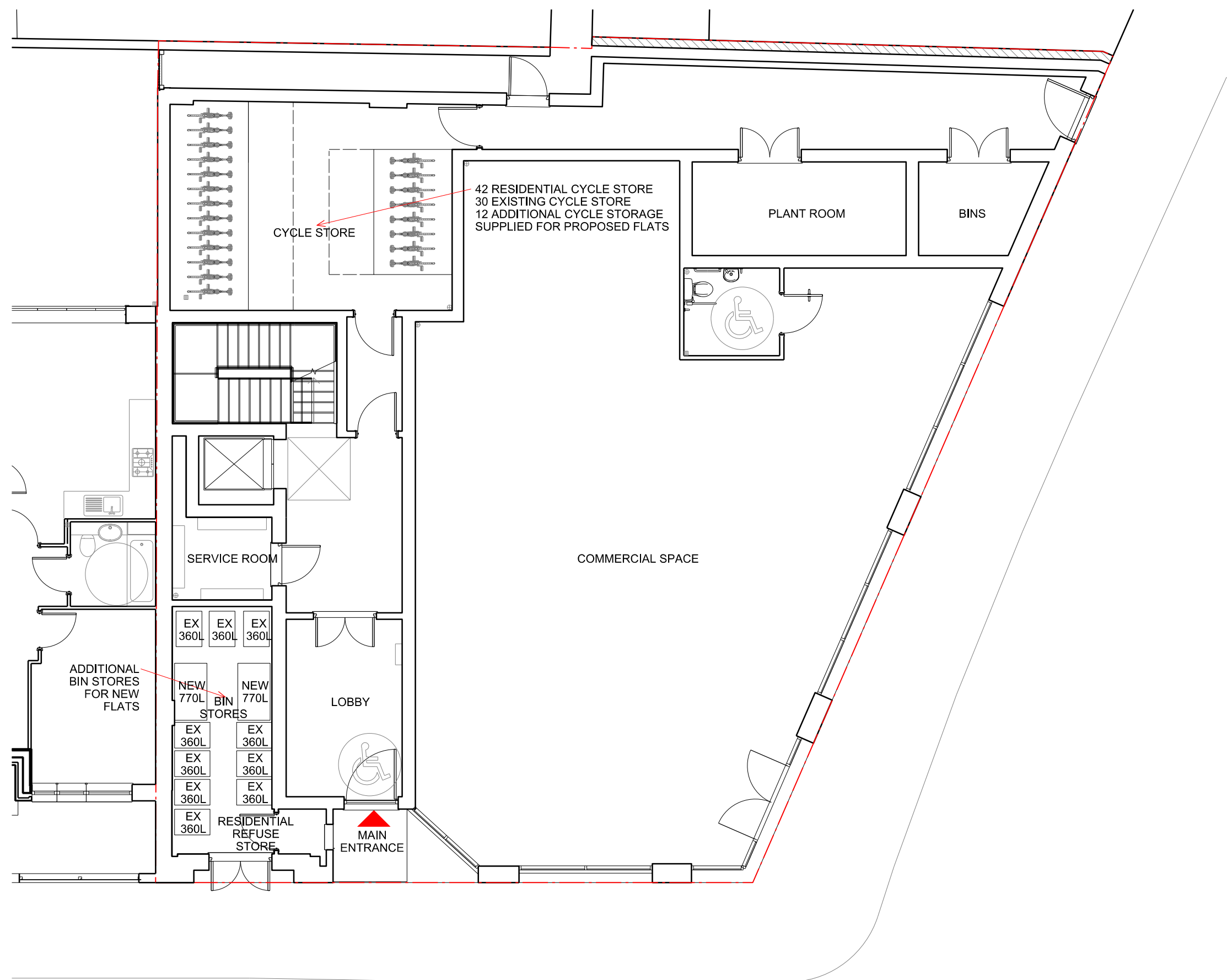

GROUND FLOOR PLAN WITH SPACES FOR CYCLES/BINS INDICATED



EXISTING FIFTH FLOOR

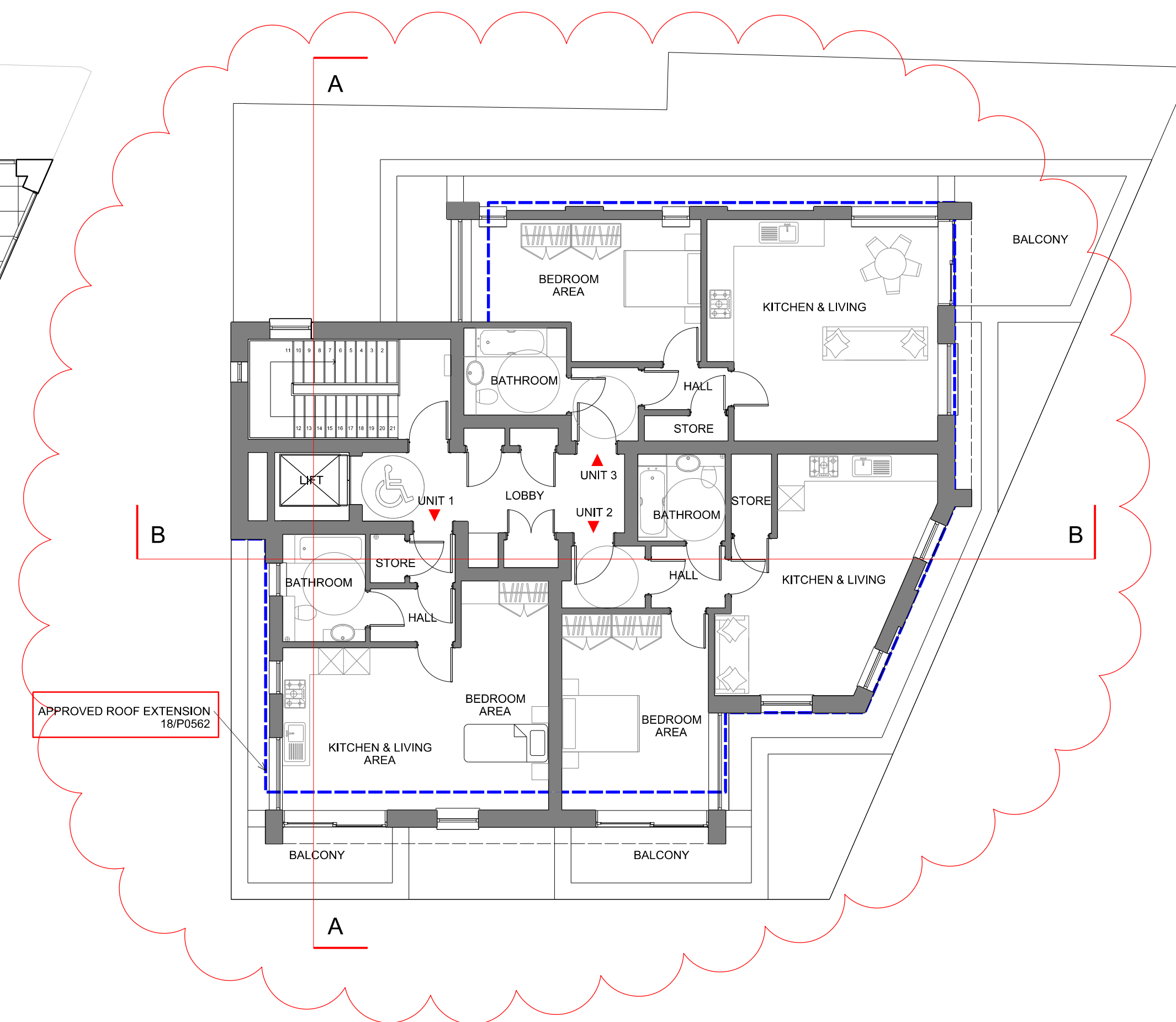

PROPOSED SIXTH FLOOR PLAN

Page 32

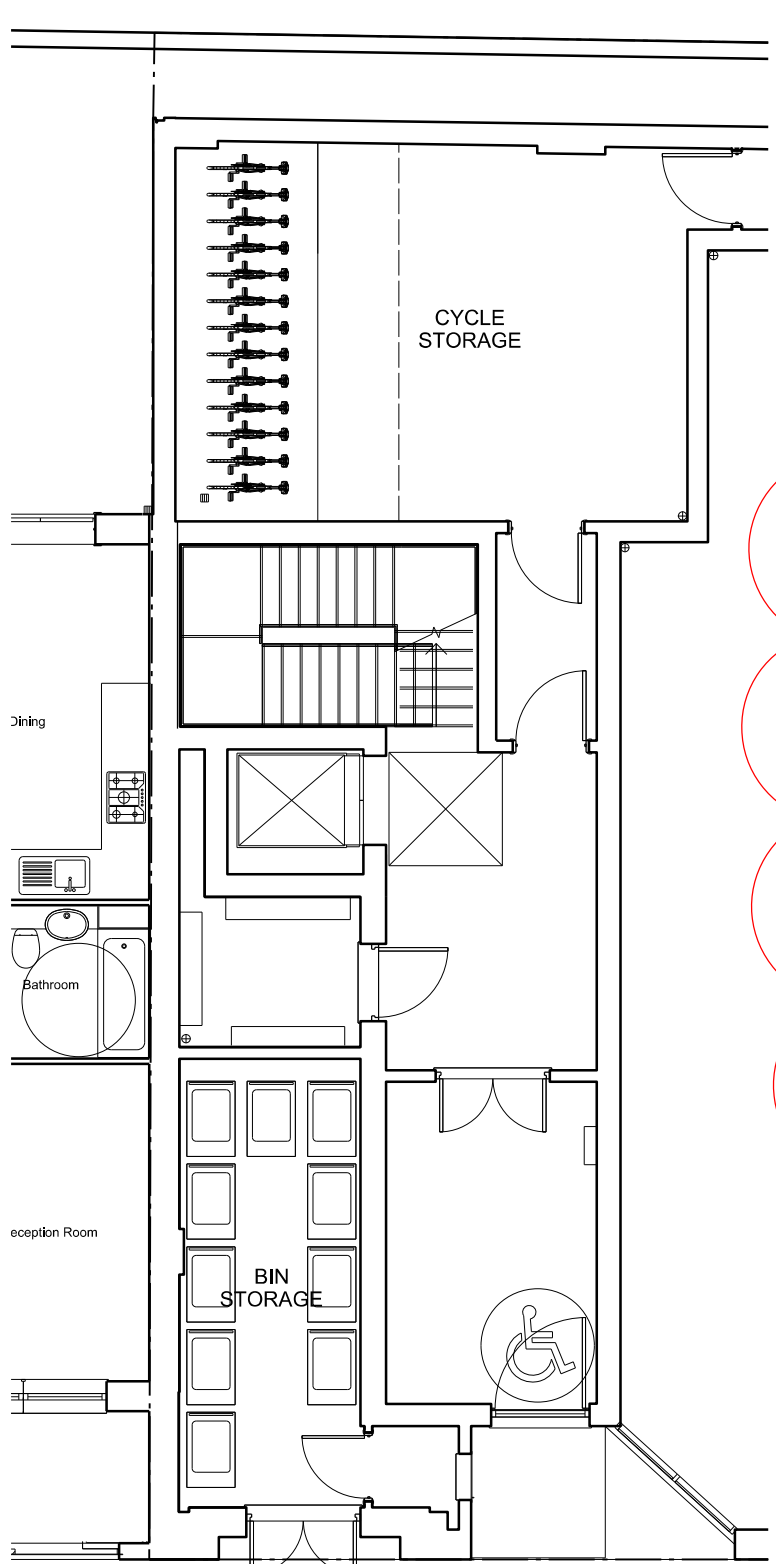

EXISTING GROUND FLOOR CYCLE/BIN AREA

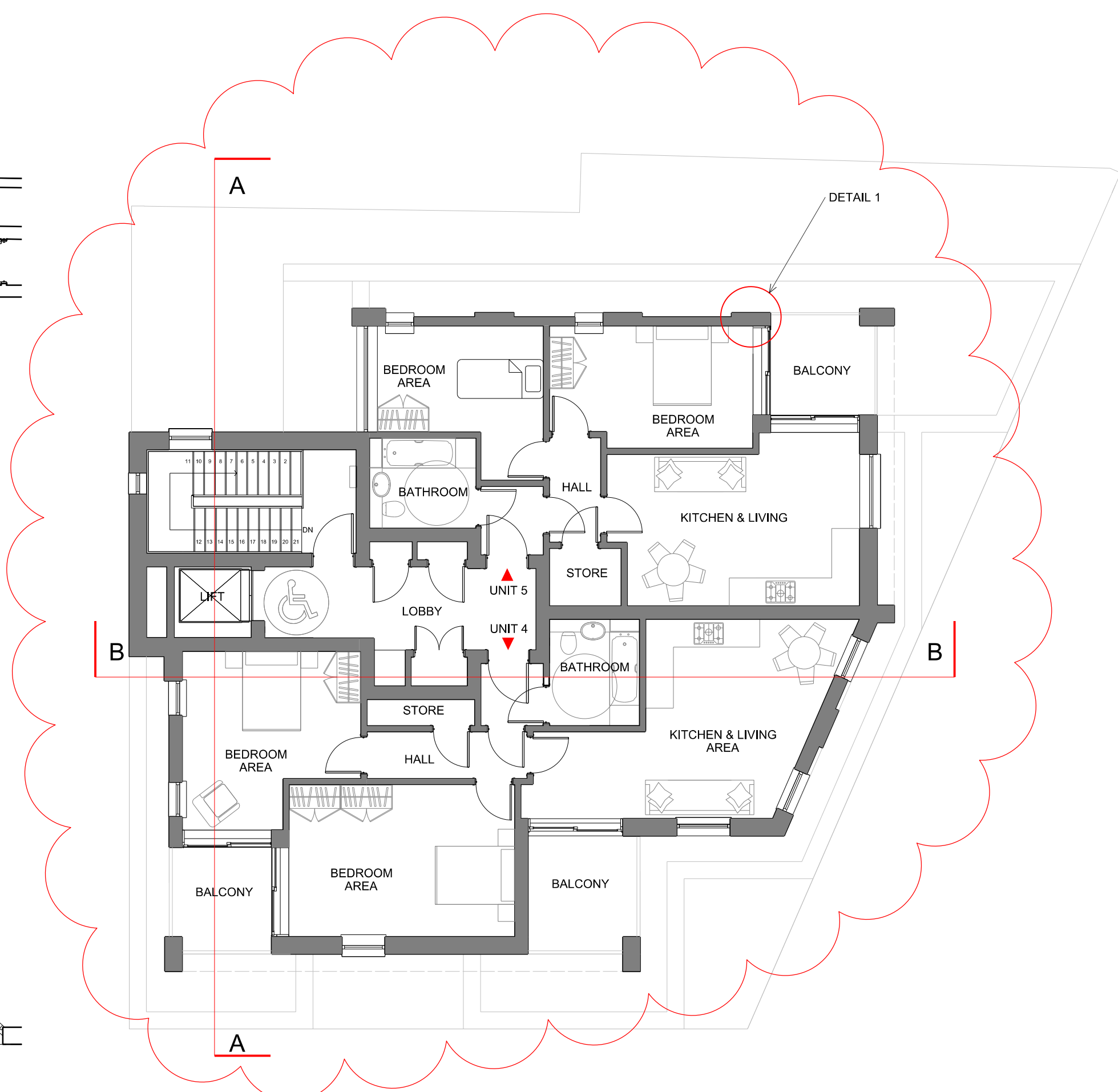

PROPOSED SEVENTH FLOOR PLAN

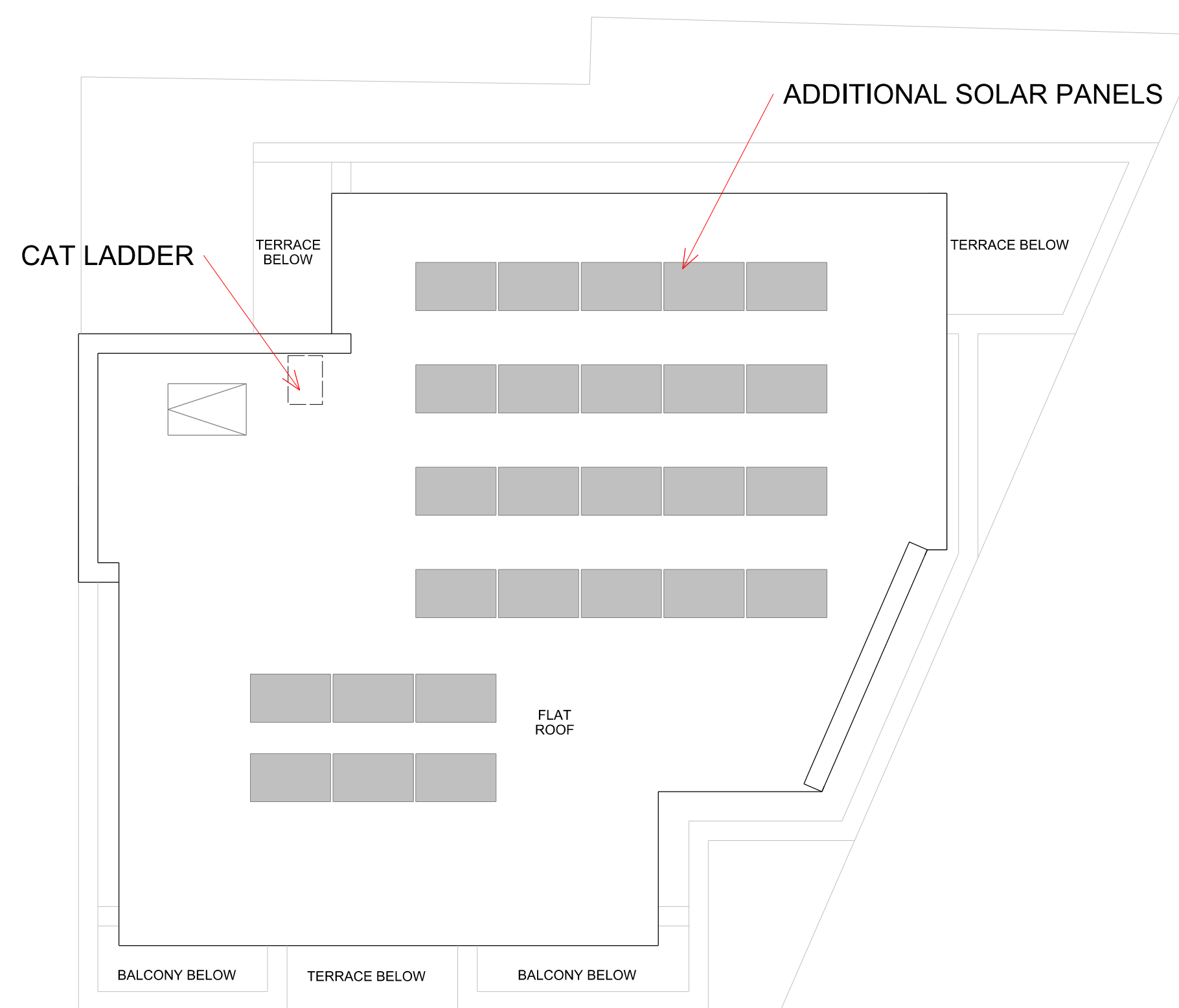

PROPOSED ROOF

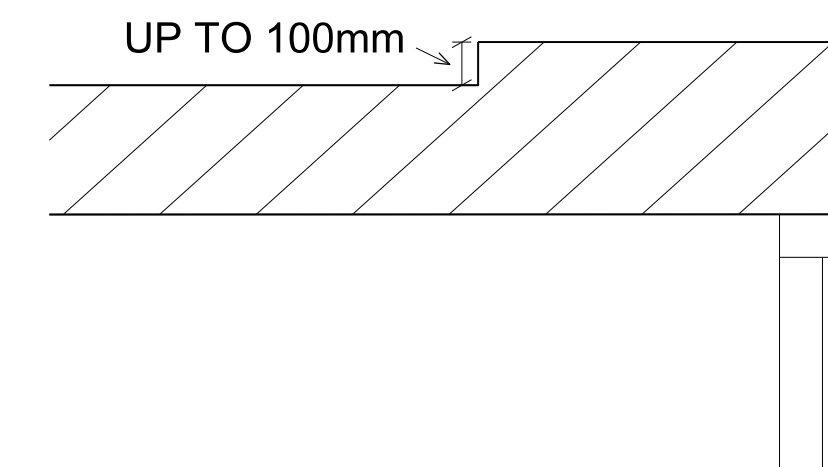

DETAIL 1 - TYPICAL RECESS DETAIL

SCHEDULE OF ACCOMMODATION:

FLAT	ACCOMMODATES	AREA m <sup>2</sup>	BALCONY m <sup>2</sup>
UNIT 1	STUDIO	39.4	4.4
UNIT 2	1B 2P	58.8	5.6
UNIT 3	1B 2P	61.5	10.2
UNIT 4	2B 4P	73.1	12.2
UNIT 5	2B 3P	61.2	6.6

REVISION	DATE	COMMENTS	AUTHOR / CHECKED
H	03/04/2020	ADJUSTMENTS AS PER PLANNING OFFICER'S COMMENTS	FS / DS
G	23/03/2020	GENERAL AMENDMENTS	FS / DS
F	19/03/2020	GENERAL AMENDMENTS	FS / DS
E	28/02/2020	MATERIALS AMENDED	EH / DS
D	07/02/2020	MATERIALS ADDED	EH / DS
C	28/01/2020	ADJUSTMENTS AS PER PLANNING RECOMMENDATIONS	PB / DS
B	10/12/2019	CYCLE STORAGE INCREASE	EH / DS
A	14/10/2019	BALCONIES INSIDE, CHANGES IN RELATION TO PLANNING OFFICER'S COMMENTS	OP / DS

DS SQUARED ARCHITECTS 25 BRISTOL SQUARE, WIMBLEDON, LONDON HA9 7EB  
 020 8732 5620 www.dssquared.co.uk dssquared.co.uk

TITLE  
 MADISON HEIGHTS, 2A MILNER ROAD, WIMBLEDON, SW19 3AA

DETAIL  
 PROPOSED FLOOR PLANS SIXTH TO EIGHT FLOOR

DATE SCALE PAPER SIZE AUTHOR \ CHECKED  
 OCT 19 1:100, 1:200 A1 KR/DS

DRAWING No. REV. STATUS  
 18019 FP 01.03 H FULL PLANNING

SCALE BAR  
 m 1 5 10 15





**FINISHES**

- ① VMZINC PIGMENTO BROWN VERTICAL STANDING SEAM CLADDING PANEL



- ② PANEL TO MATCH EXISTING (THE LARGER PANELS)



EAST ELEVATION



SOUTH ELEVATION

REVISION	DATE	COMMENTS	AUTHOR / CHECKED
E	28/02/2020	MATERIALS AMENDED	EH / DS
D	25/02/2020	MATERIALS AMENDED	EH / DS
C	07/02/2020	MATERIALS ADDED	EH / DS
B	28/01/2020	CLADDING FEATURE SURROUNDING ADD AND LABELLING UPDATES	PB / DS
A	14/10/2019	BALCONIES INSIDE, CHANGES IN RELATION TO PLANNING OFFICERS COMMENTS	OP / DS

DS SQUARED ARCHITECTS 5 SPRING VILLA ERODIA RE LONDON HA8 7EB  
 020 8732 5620 www.dssquared.co.uk designedssquared.co.uk

TITLE			
MADISON HEIGHTS, 2A MILNER ROAD, WIMBLEDON, SW19 3AA			
DETAIL			
PROPOSED SOUTH & EAST ELEVATION			
DATE	SCALE	PAPER SIZE	AUTHOR / CHECKED
OCT 19	1:100	A1	OP / DS
DRAWING No.	REV.	STATUS	
18019 FP 01.04	E	FULL PLANNING	

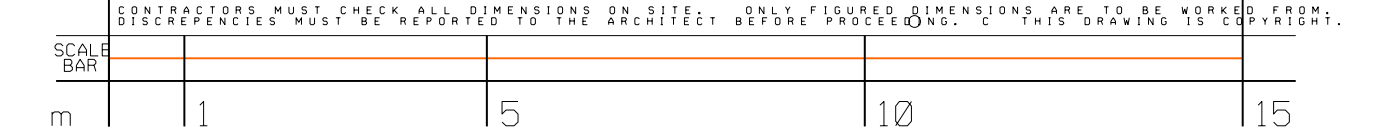





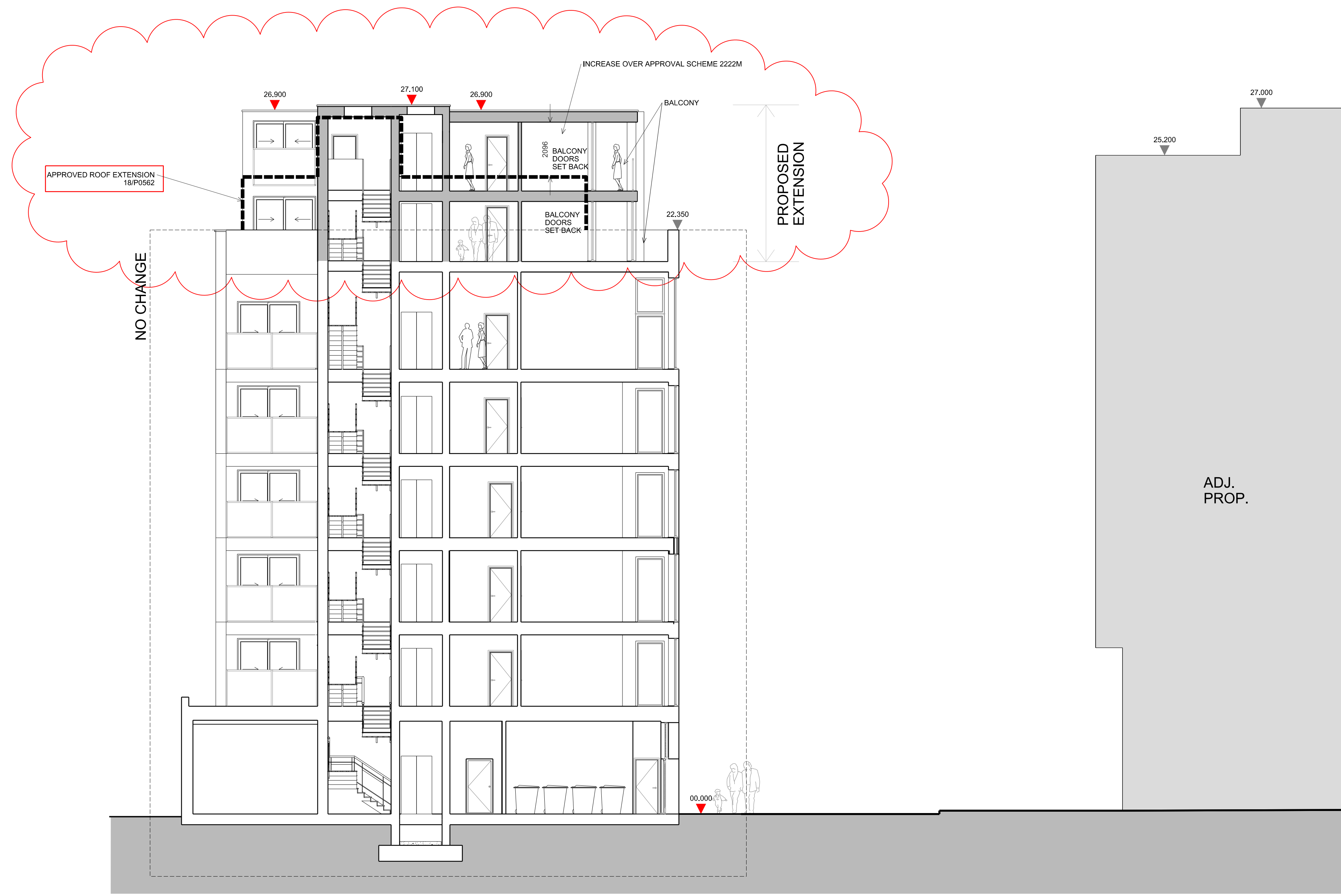

SECTION A-A

B	23/03/20	MINOR AMENDMENTS	FS / DS
A	14/10/2019	BALCONIES INSIDE, CHANGES IN RELATION TO PLANNING OFFICER'S COMMENTS	OP / DS
REVISION	DATE	COMMENTS	AUTHOR / CHECKED
DS SQUARED ARCHITECTS	020 8732 5620	WWW.DSSQUARED.CO.UK	DESIGNEDSSQUARED.CO.UK
TITLE MADISON HEIGHTS, 2A MILNER ROAD, WIMBLEDON, SW19 3AA DETAIL PROPOSED SECTION			
DATE	SCALE	PAPER SIZE	AUTHOR \ CHECKED
OCT 19	1:100	A1	OP / DS
DRAWING No.	REV.	STATUS.	
18019 FP 01.07	B	FULL PLANNING	
SCALE BAR m   1   5   10   15			

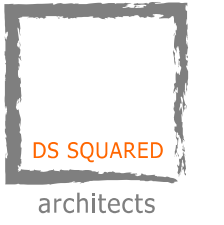





C	03/04/20	UPDATED CGI'S ADDED	FS/DS
B	23/3/20	UPDATED CGI'S ADDED	FS/DS
A	24/10/19	ARTIST IMPRESSION CHANGES TO REFLECT CHANGES TO PLANS	EH/DS
REVISION	DATE	COMMENTS	AUTHOR / CHECKED

DS SQUARED ARCHITECTS 6 BRUSSELS SPRING VILLA EROGAWA RE LONDON HA8 7EB  
 020 8732 5620 www.dssquared.co.uk designedsquared.co.uk

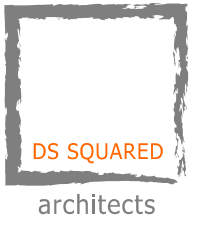
TITLE				
MADISON HEIGHTS, 2A MILNER ROAD, WIMBLEDON, SW19 3AA				
DETAIL				
ARTIST'S IMPRESSION VISUALISATION				
DATE	SCALE	PAPER SIZE	AUTHOR \ CHECKED	
NOV 19	NTS	A1	FL / DS	
DRAWING No.	REV.	STATUS.		
18019 FP 01.06	C	FULL PLANNING		



## PLANNING APPLICATIONS COMMITTEE

28<sup>th</sup> May 2020

<u>UPRN</u>	<u>APPLICATION NO.</u>	<u>Item No:</u> <u>DATE VALID</u>
	20/P0420	20/01/2020
<b>Address/Site</b>	The All England Lawn Tennis and Croquet Club Church Road, Wimbledon, London, SW19 5AE	
<b>(Ward)</b>	Village	
<b>Proposal:</b>	Erection of a two storey media pavilion, replacement of temporary cabins with a dedicated technical services room (TSR), and reconfiguration of gate 20 including the relocation and widening of existing access/egress, relocation of existing gatehouse building, new accreditation hut and gatehouse building, landscaping and associated works.	

### To consider:

- In light of the representation received by Mr Tony Rudd CBE Chairman Oakfield Residents Ltd, do members wish to make any further comments on the application. The representation was received by the Council prior to the committee meeting of the 14<sup>th</sup> May 2020, however, it was not processed due to an administrative error and therefore was not read out during the meeting.

This page is intentionally left blank

## **Committee:** Planning Applications Committee

**Date:** 28<sup>th</sup> May 2020

**Agenda item:**

**Wards:** All

**Subject:** PLANNING ENFORCEMENT - SUMMARY OF CURRENT CASES

**Lead officer:** HEAD OF SUSTAINABLE COMMUNITIES

**Lead member:** CABINET MEMBER FOR REGENERATION, HOUSING AND  
TRANSPORT COUNCILLOR MARTIN WHELTON

**COUNCILLOR LINDA KIRBY, CHAIR, PLANNING APPLICATIONS COMMITTEE**

**Contact Officer** Ray Littlefield: 0208 545 3911  
Ray.Littlefield@merton.gov.uk

### **Recommendation:**

---

That Members note the contents of the report.

---

#### **1. Purpose of report and executive summary**

This report details a summary of casework being dealt with by the Planning Enforcement Team and contains figures of the number of different types of cases being progressed, with brief summaries of all new enforcement notices and the progress of all enforcement appeals.

<b>Current Enforcement Cases:</b>	<b>401</b>	<sup>1</sup> (398)	<b>New Appeals:</b>	(0)	(0)
<b>New Complaints</b>	23	(32)	<b>Instructions to Legal</b>	<b>0</b>	(0)
<b>Cases Closed</b>	<b>20</b>		<b>Existing Appeals</b>	<b>5</b>	(5)
No Breach:	15		<hr/>		
Breach Ceased:	5		<b>TREE ISSUES</b>		
NFA <sup>2</sup> (see below):	0		<b>Tree Applications Received</b>	<b>3</b>	<b>(48)</b>
Total	20		<b>% Determined within time limits:</b>	<b>100%</b>	
<b>New Enforcement Notices Issued</b>			<b>High Hedges Complaint</b>	<b>0</b>	<b>(0)</b>
Breach of Condition Notice:	0		<b>New Tree Preservation Orders (TPO)</b>	<b>3</b>	<b>(3)</b>
New Enforcement Notice issued	0	(0)	<b>Tree Replacement Notice</b>	<b>0</b>	
S.215: <sup>3</sup>	0		<b>Tree/High Hedge Appeal</b>	<b>0</b>	<b>(0)</b>
Others (PCN, TSN)	0	(0)			
Total	0	(0)			
<b>Prosecutions:</b> (instructed)	0	(0)			

Note (*figures are for the period from (5<sup>th</sup> May 2020 to 15<sup>th</sup> May 2020*). The figure for current enforcement cases was taken directly from M3 crystal report.

<sup>1</sup> Totals in brackets are previous month's figures

<sup>2</sup> confirmed breach but not expedient to take further action.

<sup>3</sup> S215 Notice: Land Adversely Affecting Amenity of Neighbourhood.

## 2.0 New Enforcement Actions

**283 Galpins Road CR7 6EY.** This is concerning a s215 notice served on untidy land. A s215 notice was issued on 23 December 2019. This notice required compliance at the end of February 2020 requiring the Land to be tidied up / cleared.

**31 Edgehill Road, Mitcham, CR4 2HY.** This is concerning a raised platform/garden that has been raised by approximately 90cm. An enforcement notice has been served to remove the raised platform and reduce the garden level by 90cm. The notice would have taken effect on 18/12/19, with a compliance date of 18/03/20, however an appeal has been submitted and is underway.

**193 London Road CR4 2TJ.** This is concerning untidy land to the side and rear of 193 London Road. An initial site visit was carried out, multiple letters have been sent to the property asking for compliance and for them to contact the Council to confirm a compliance schedule of works. Correspondence from the owner has been received. A further visit was made to confirm the site has not been tidied. A s215 enforcement Notice for untidy land has been drafted and is due to be reviewed and signed off by a manager authorising the service of a s215 Notice.

**155 Canterbury Road, Morden, SM4 6QG.** This is concerning an outbuilding in the rear garden that has had a retrospective planning application refused. An enforcement notice has been served on the property for the outbuilding to be demolished, the notice would have taken effect on 9th December 2019 and the compliance period would have been two months. However it has now been appealed to the Planning Inspectorate. The appeal is now ongoing.

**208 Bishopsford Road, Morden, SM4 6DA.** This is concerning the erection of a single storey rear extension onto an existing extension on the ground floor. A Planning Enforcement Notice has been issued requiring the demolition of the Extension. The Notice was issued on 4<sup>th</sup> October 2019, the Notice came into effect on 10<sup>th</sup> November 2019 with a compliance period of 3 months, unless an appeal was made before 10<sup>th</sup> November 2019. An appeal was submitted but rejected by the Planning Inspectorate as it was received by The Planning Inspectorate one day late. Compliance date was 10<sup>th</sup> February 2020. Further action is under consideration

**The former laundry site, 1 Caxton Road, Wimbledon SW19 8SJ.** Planning Permission was granted for 9 flats, with 609square metres of (Class B1) office units. 22 flats have been created. A Planning Enforcement Notice was issued on 11th October 2018 requiring either the demolition of the development or building to the approved scheme. The Notice took effect on 18th November 2018 with a compliance period of 12 calendar months. An appeal was made but subsequently withdrawn the following day. The owner decided to comply with the approved permission and is in the process of returning some the residential units back to their authorised office use. Bath and shower units have been removed; the office units are currently being advertised for let. The garage flat is no longer being used for residential and is in the process of being returned to a garage. Planning Application 19/P1527 for Discharge of Conditions has been submitted and is currently being considered. Revised scheme re-submitted and is currently under consideration.

**6 CARTMEL GARDENS, MORDEN SM4 6QN: (Notice 2)** This is regarding a side extension not built in accordance with approved plans and being used as a self contained unit of accommodation. A planning Enforcement Notice was subsequently issued on 24th September 2019 and took effect on 24th October 2019. The Notice requires the cessation of the use of side extension as separate self-contained unit, and the removal of all those fixtures and fittings that facilitate the unauthorised use of the extension including the permanent removal of the facilities in use for cooking facilities, kitchen unit, sink, worktop, appliances, and food preparation areas. This Notice has a

compliance period of 3 calendar months. An appeal was submitted but subsequently withdrawn. A second Notice is subject of an appeal in progress.

### **Some Recent Enforcement Actions**

#### **7 Streatham Road, Mitcham, CR4 2AD**

The Council served two enforcement notices on 6<sup>th</sup> June 2019, requiring the outbuilding to be demolished and to clear debris and all other related materials. The second enforcement notice is for an unauthorised front, side and rear (adjacent to Graham Road) dormer roof extensions. An appeal was lost for the dormers to be considered permitted development, the notice requires the owner to demolish the unauthorised front, side and rear roof dormer extensions (adjacent to Graham Road) and to clear debris and all other related materials. Both Notices came into effect on 8<sup>th</sup> July 2019 unless appeals were made before this date. No appeals were lodged.

The compliance date of the Enforcement Notice relating to the outbuilding to be demolished and to clear debris and all other related materials has now passed without compliance. The second enforcement notice was not complied with and now prosecution proceedings are being undertaken.

The plea hearing has now taken place at Lavender Hill Magistrates Court, where the defendant pleaded not guilty and the second hearing is due on the 14th January 2020.

A second hearing was held on 14<sup>th</sup> January 2020, and adjourned until 4<sup>th</sup> February 2020 in order for the defendant to seek further legal advice.

The defendant again appeared in court and pleaded not guilty, a trial date was set for 21<sup>st</sup> May 2020. Due to the Covid-19 pandemic this has been postponed. The case has been listed for a 'non-effective' hearing on Tuesday 14 July 2020, where a new trial date will be set.

#### **3.00 New Enforcement Appeals**

**6 CARTMEL GARDENS, MORDEN SM4 6QN: (Notice 1)** This is regarding a side extension not built in accordance with approved plans. A planning Enforcement Notice was subsequently issued on 24<sup>th</sup> September 2019 and would have taken effect on 24<sup>th</sup> October 2019. The notice requires the demolition of the rear extension. This Notice has a compliance period of 3 calendar months. An Appeal was electronically submitted, and has now started.

**183A Streatham Road CR4 2AG.** An Enforcement Notice was issued on 1<sup>st</sup> May 2019 relating to the erection of a rear balcony to the existing rear roof dormer of the property. The Notice requires demolishing the rear balcony to the existing rear roof dormer and restoring the property to that prior to the breach. The Notice would have taken effect on 4<sup>th</sup> June 2019, with a compliance period of 2 months. An Appeal to The Planning Inspectorate has been made and the Appeal is in progress.

**47 Edgehill Road CR4 2HY.** This is concerning a rear extension not being built to the dimensions provided on the prior approval application. A Planning Enforcement Notice was subsequently issued requiring the demolition of the single storey rear extension. The Notice would have taken effect took effect on 16th September 2019, with a compliance period of 3 calendar months. An Appeal has started.

**33 HASSOCKS ROAD, LONDON. SW16 5EU:** This was regarding the unauthorised conversion from a single dwelling into 2 x self contained flats against a refusal planning permission. A planning Enforcement Notice was subsequently issued on 10th September 2019 and would have taken effect on 15th October 2019. This Notice has a compliance period of 3 calendar months, unless an appeal is made to the Planning Inspectorate before the Notice takes effect. An Appeal has been submitted, and has started. The appeal site visit was postponed, by The Planning Inspectorate.

**76 Shaldon Drive, Morden, SM4 4BH.** An enforcement notice was served on 14th August 2019 relating to an outbuilding being used as a self-contained unit. The notice requires the removal of all kitchen facilities, fixtures, fittings, cooker, worktops, kitchen units. The notice takes effect on 16th September 2019, with a compliance period of 1 month. An Appeal has been electronically submitted, but not yet started.

<b><u>Existing enforcement appeals</u></b>	5
<b><u>Appeals determined</u></b>	0

**3.4 Requested update from PAC**

None

**4. Consultation undertaken or proposed**

None required for the purposes of this report

**5 Timetable**

N/A

**6. Financial, resource and property implications**

N/A

7. **Legal and statutory implications**  
N/A
8. **Human rights, equalities and community cohesion implications**  
N/A
9. **Crime and disorder implications**  
N/A
10. **Risk Management and Health and Safety implications.**  
N/A
11. **Appendices – the following documents are to be published with this report and form part of the report Background Papers**  
N/A
12. **Background Papers**